

REGULATORY SIGNS
FLAT SHEET SIGNS

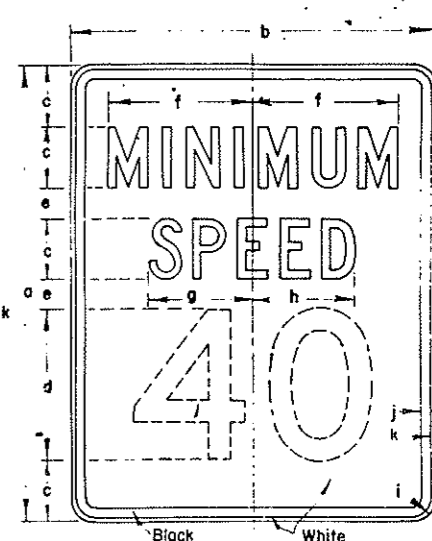
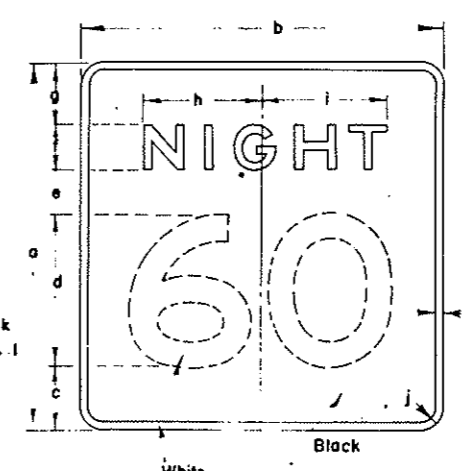
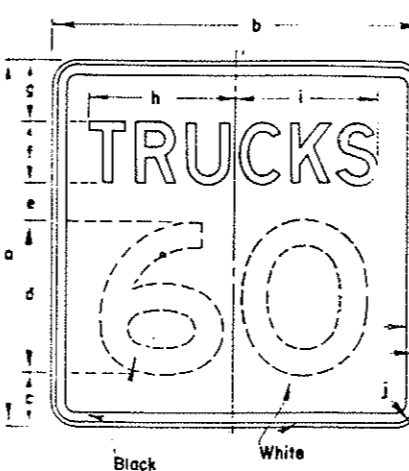
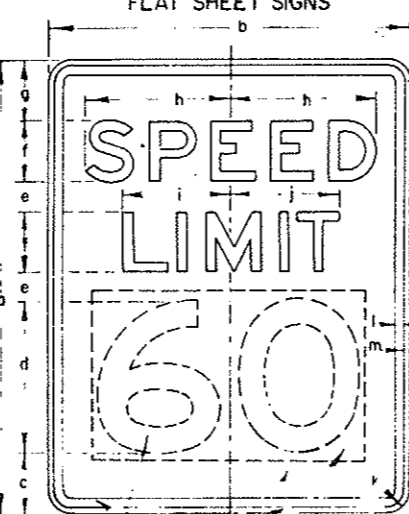
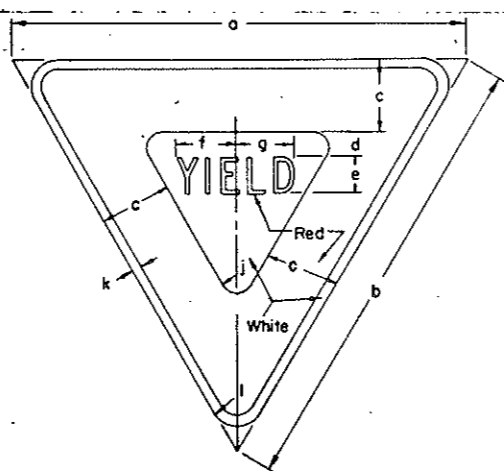
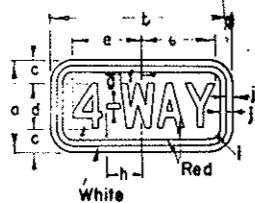
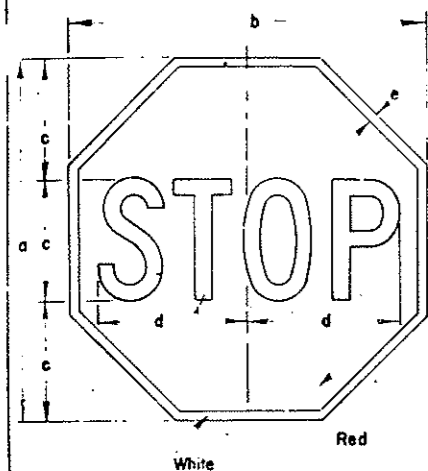

SIGN NUMBER			
	R-1-48	R-1-36	R-1-30
a	48	36	30
b	48	36	30
c	16C	12C	10C
d	20 1/4	15 3/8	12 3/8
e	1 1/4	7/8	3/4
Area	13.25	7.46	5.18

SIGN NUMBER		
	R-2-24	R-2-12
a	12	6
b	24	12
c	3	1 1/2
d	6C	3C
e	9 3/4	4 7/8
f	2 3/4	1 3/8
g	27 3/8	27 6/8
h	10 1/2	5 1/4
i	3	1 1/2
j	3/4	3/8
Area	2.00	0.50

SIGN NUMBER			
	R-203-60	R-203-48	R-203-36
a	60	48	36
b	60	48	36
c	9	7 1/2	5 1/2
d	3	2 3/8	1 3/8
e	5C	4C	3C
f	7 3/8	5 5/16	4 1/16
g	7 7/8	5 23/32	4 7/8
h			
i	2	1 3/8	1 3/16
j	1	3/4	1/2
k	1	3/4	1/2
Area	10.82	6.93	3.90

SIGN NUMBER			
	R-4-48	R-4-36	R-4-24
a	48	36	24
b	48	36	24
c	9	7 1/2	6
d	3	2 3/8	2
e	5C	4C	3C
f	7 3/8	5 5/16	4 1/16
g	7 7/8	5 23/32	4 7/8
h			
i	2	1 3/8	1 3/16
j	1	3/4	1/2
k	1	3/4	1/2
Area	10.82	6.93	3.90

** NOTE: The numeral area shall have a non-reflectORIZED background as shown when used with Sign No. R-6-48, 36 or 24.

SIGN NUMBER			
	R-5-48	R-5-24	R-5-36
a	48	24	36
b	48	24	36
c	7	3 1/2	5 1/4
d	20E	10E	15E
e	5	2 1/2	3 3/4
f	8D	4D	6D
g	8	4	6
h	19 1/8	9 5/16	14 15/32
i	18 3/8	9 3/16	13 25/32
j	3	1 1/2	2 1/4
k	1 1/4	5/8	15/16
l	3/4	3/8	5/16
Area	16.00	4.00	9.00

SIGN NUMBER			
	R-6-48	R-6-24	R-6-36
a	48	24	36
b	48	24	36
c	8	4	6
d	20E	10E	15E
e	6	3	4 1/2
f	6F	3F	4 1/2 F
g	8	4	6
h	15 3/8	7 15/16	11 29/32
i	13 3/8	6 15/16	10 11/16
j	3	1 1/2	2 1/4
k	1	1/2	3/4
Area	16.00	4.00	9.00

SIGN NUMBER		
	R-7-48	R-7-24
a	60	30
b	48	24
c	8C	4C
d	20D	10D
e	4	2
f	19	9 1/2
g	13 3/8	6 15/16
h	13 3/8	6 11/16
i	3	1 1/2
j	1 1/4	5/8
k	3/4	3/8
Area	20.00	5.00

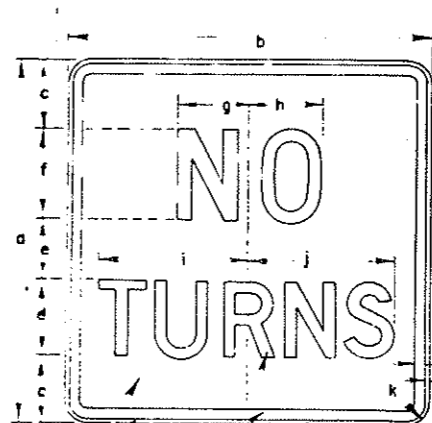
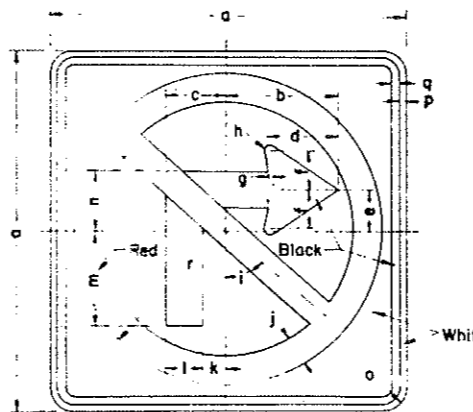
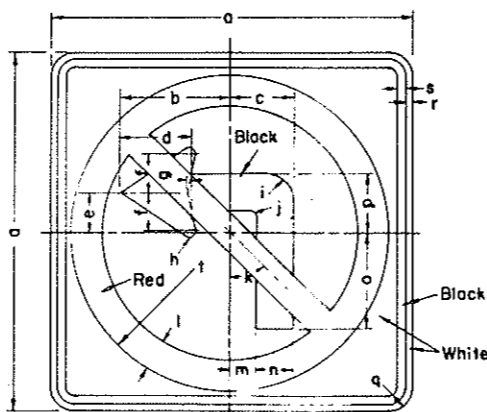
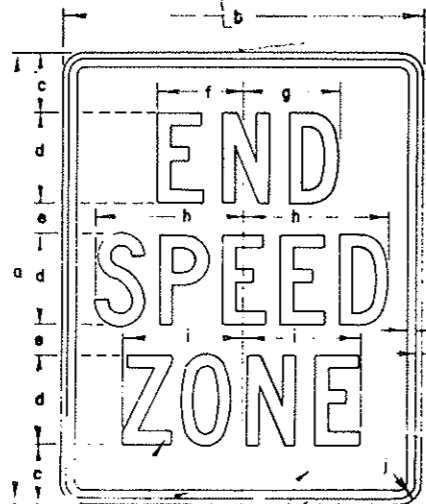
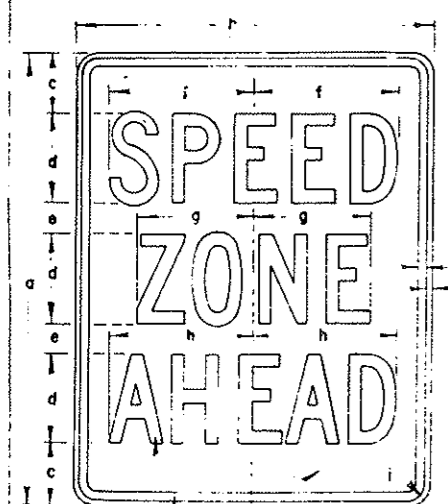

NOTE: See plans for correct message on all signs. All signs have reflectORIZED message, border and background unless shown otherwise on the plans. In no case is the color black reflectORIZED.

SIGN NUMBER			
	R-8-24	R-8-36	R-8-48
a	60	30	48
b	48	24	36
c	8	4	6
d	12C	6C	9C
e	4	2	3
f	19 1/2	9 3/4	14 3/8
g	15 3/4	7 3/8	11 1/4
h	19 1/2	9 3/4	14 3/8
i	3	1 1/2	2 1/4
j	1 1/4	5/8	15/16
k	3/4	3/8	9/16
Area	12.00	5.00	12.00

SIGN NUMBER			
	R-9-24	R-9-36	R-9-48
a	60	30	48
b	48	24	36
c	8	4	6
d	12C	6C	9C
e	4	2	3
f	11 1/2	5 3/4	8 3/8
g	12 1/2	6 1/4	9 3/8
h	19 1/2	9 3/4	14 3/8
i	15 3/4	7 3/8	11 1/4
j	3	1 1/2	2 1/4
k	1 1/4	5/8	15/16
l	3/4	3/8	9/16
Area	12.00	5.00	12.00

SIGN NUMBER			
	R-210-48	R-210-36	R-210-24
a	48	36	24
b	14 1/2	10 7/8	7 1/4
c	8 1/2	6 3/8	4 1/4
d	9 1/2	7 1/8	4 3/4
e	5 1/2	4 1/8	2 3/4
f	5 1/4	3 3/8	2 5/8
g	3 3/4	2 3/8	1 3/4
h	3/4	9/16	3/8
i	4	3	2
j	1 1/2	1 1/8	3/4

SIGN NUMBER			
	R-25-48	R-25-36	R-25-24
k	45°	45°	45°
l	4	3	2
m	3 1/2	2 3/8	1 3/4
n	5	3 3/4	2 1/2
o	12 1/2	9 3/8	6 1/4
p	3	2 1/4	1 1/2
q	3	2 1/4	1 1/2
r	3/4	5/8	3/8
s	1 1/4	1	3/8
t	2 1/2	1 5/8	1 1/2

SIGN NUMBER			
	R-211-48	R-211-36	R-211-24
a	48	36	24
b	14 1/2	10 7/8	7 1/4
c	8 1/2	6 3/8	4 1/4
d	9 1/2	7 1/8	4 3/4
e	5 1/2	4 1/8	2 3/4
f	5 1/4	3 3/8	2 5/8
g	3 3/4	2 3/8	1 3/4
h	3/4	9/16	3/8
i	4 5/8	4 5/8	4 5/8

SIGN NUMBER			
	R-211-48	R-211-36	R-211-24
j	4	3	2
k	3 1/2	2 3/8	1 3/4
l	5	3 3/4	2 1/2
m	12 1/2	9 3/8	6 1/4
n	3	2 1/4	1 1/2
o	3	2 1/4	1 1/2
p	3/4	5/8	3/8
q	1 1/4	1	5/8
r	2 1/2	1 5/8	1 1/2

SIGN NUMBER			
	R-12-48	R-12-24	R-12-36
a	48	24	36
b	48	24	36
c	9	4 1/2	6 3/4
d	10D	5D	7 1/2 D
e	8	4	6
f	12D	6D	9D
g	9 1/2	4 3/4	7 1/8
h	10 1/8	5 1/16	7 19/32
i	19 5/8	9 13/16	14 23/32
j	19 1/4	9 5/8	14 7/16
k	3	1 1/2	2 1/4
l	1 1/4	5/8	15/16
m	3/4	3/8	9/16
Area	16.00	4.00	9.00

DATE	REVISIONS CHANGE
4/24/72	NOTES
8-17-72	Sign Dimension
9-29-72	Changed Note
10-27-72	Sign Dimension

Square Metal and Wood Posts: See Std D-754-69-11.3 thru 11.5 for assembly details.
Round Metal Posts: See Std. D-754-71-9.1 thru 9.5 for assembly details.
Perforated Telescoping Tubes: See Std. D-754-72-12.4 thru 12.6 for assembly details.

NORTH DAKOTA
STATE HIGHWAY DEPARTMENT
Submitted: *N. B. Cassman*
Design Engineer
Recommended:
Asst. Chief Engineer, Pre-Const.
Approved: *C. J. ...*
Chief Engineer