

CONSTRUCTION SIGN DETAILS

FHWA REGION	STATE	FED AID PROJECT NO	SHEET NO
8	ND	F-1-094(03)	97

D-754-2

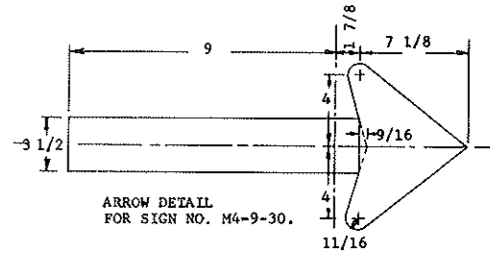
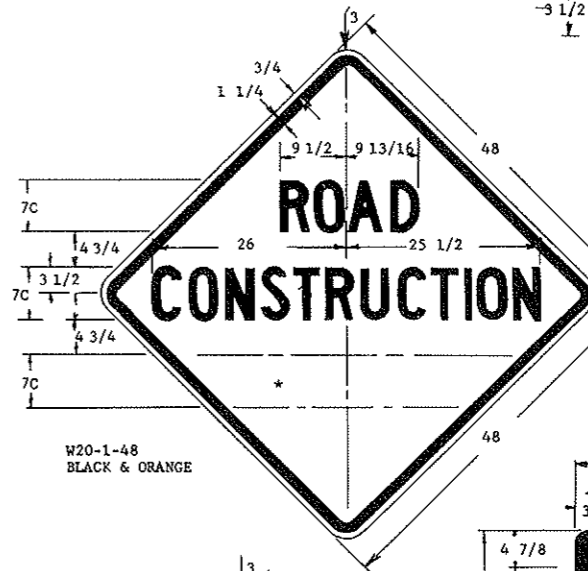
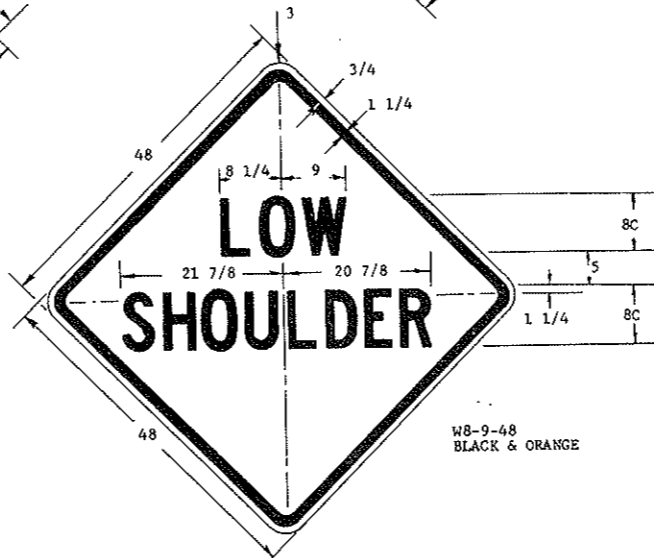
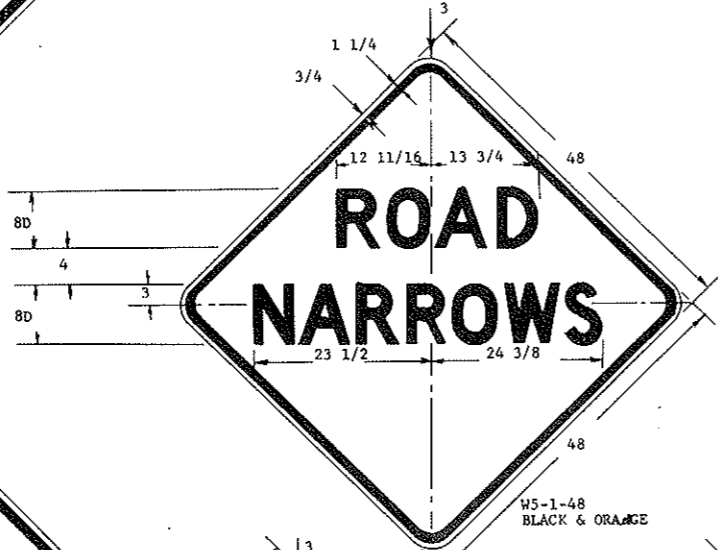
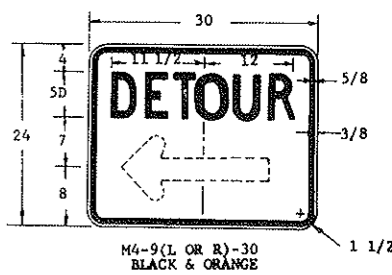
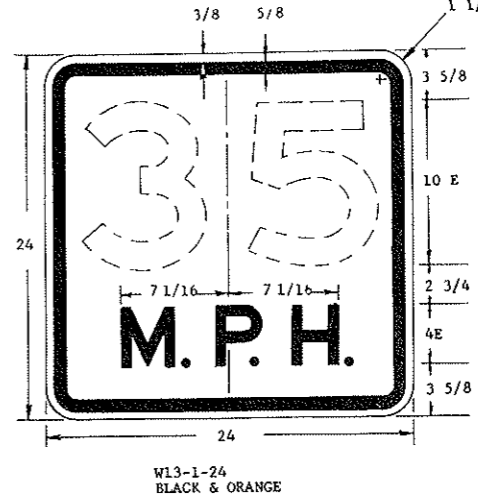
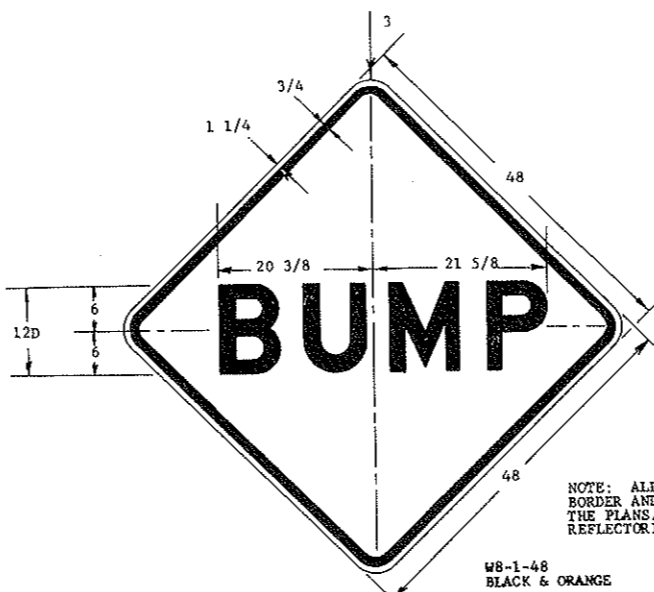
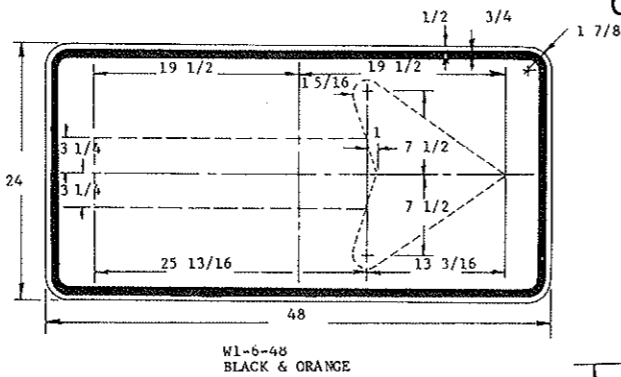
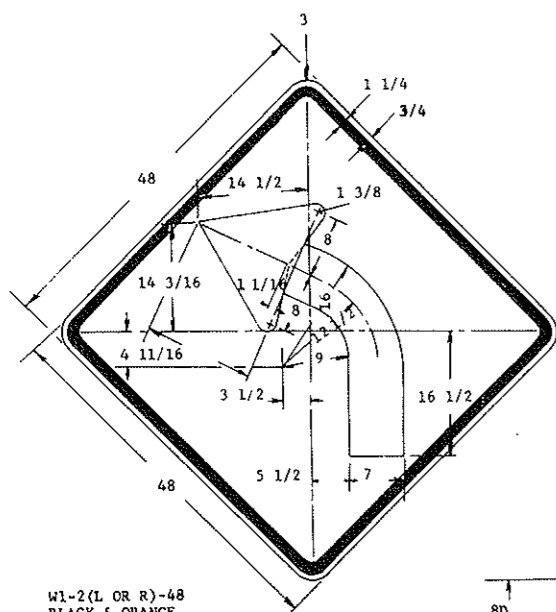

MESSAGES AND BORDERS: THE MESSAGES AND BORDERS SHALL BE SCREENED ON REFLECTIVE SHEETING OR INSTALLED USING PIGMENTED PLASTIC FILM CONFORMING TO THE REQUIREMENT OF SEC. 894-3.5 OF THE STD. SPECIFICATIONS. THE PIGMENTED PLASTIC FILM SHALL BE INSTALLED IN ACCORDANCE WITH THE REFLECTIVE SHEETING MANUFACTURERS RECOMMENDATIONS. THE BORDERS SHALL HAVE THE RADII AND WIDTH SHOWN ON THE PLANS. THE LETTERS SHALL BE FABRICATED IN ACCORDANCE WITH THE STANDARD LETTER GUIDE OF THE HEIGHT AND SERIES SHOWN ON THE PLANS. THE DETAILS OF THESE LETTERS MAY BE OBTAINED FROM THE STATE HIGHWAY DEPARTMENT OR THE SHEETING MANUFACTURER.

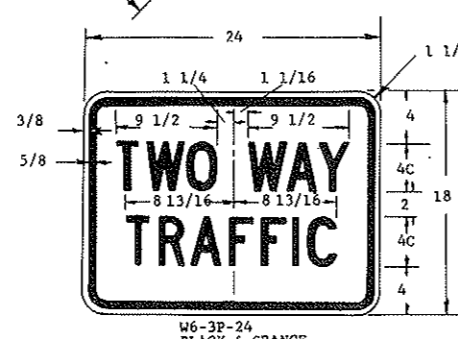
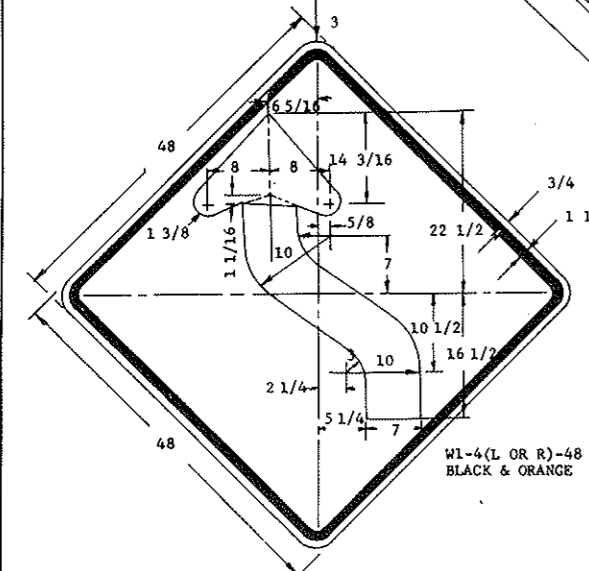
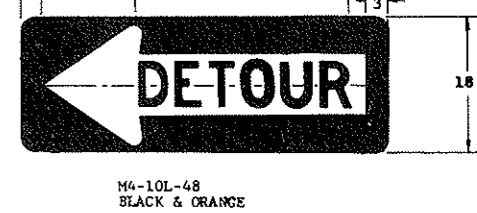
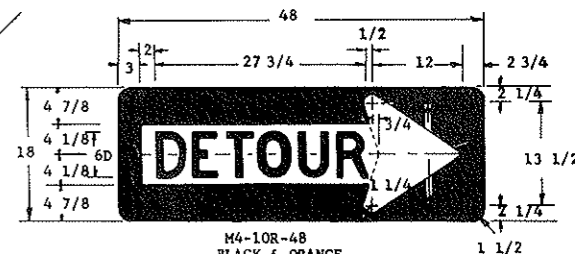
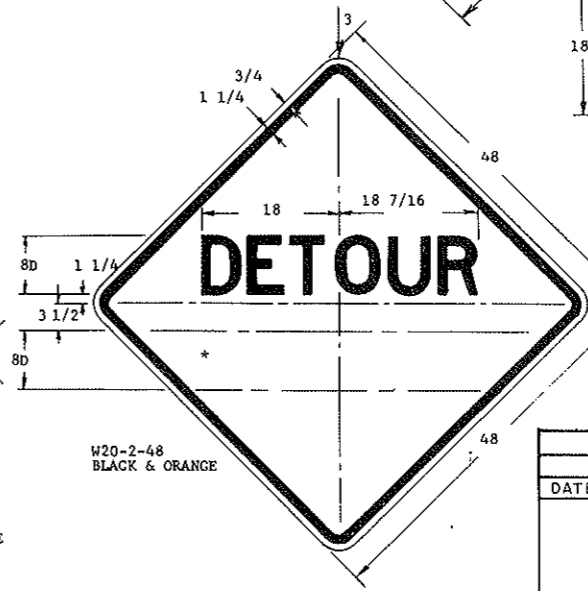
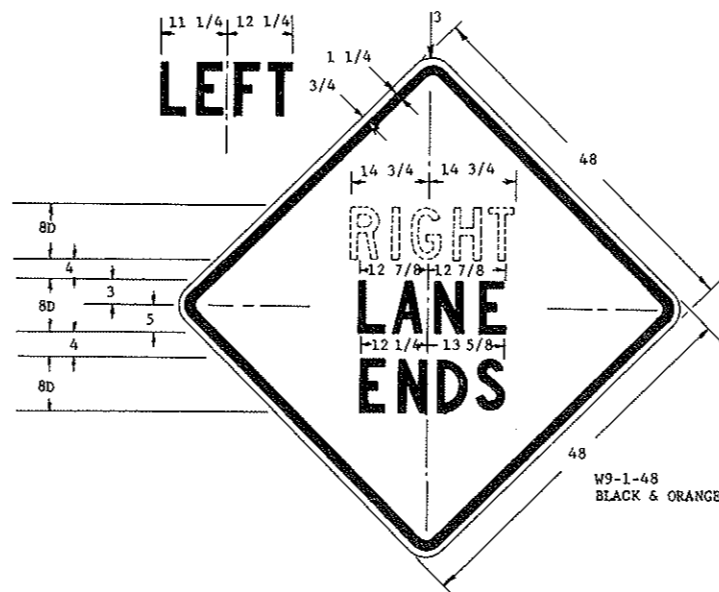
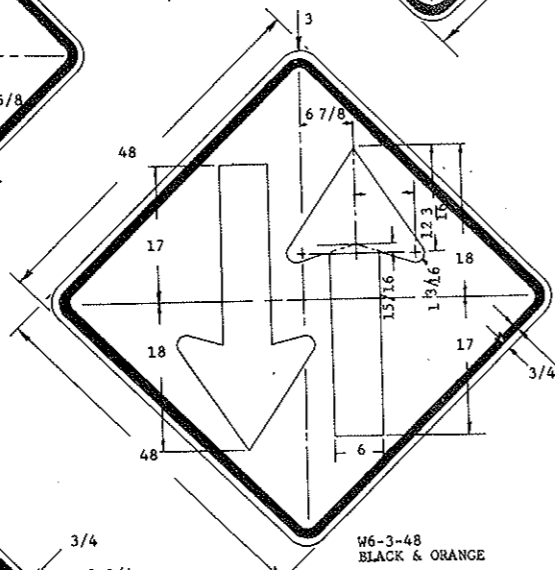
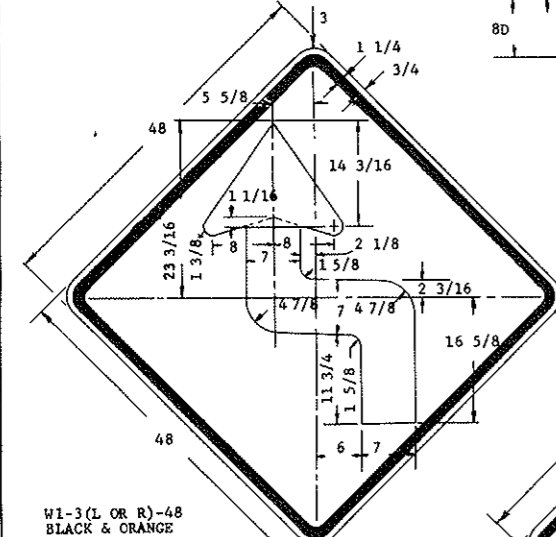

2-17-78		NORTH DAKOTA STATE HIGHWAY DEPARTMENT
REVISIONS		
DATE	CHANGE	Submitted: <i>Sheldon</i> Design Engineer
		Recommended: Asst. Chief Engineer, Pre - Constr.
		Approved: <i>Kennedy</i> Chief Engineer

CONSTRUCTION SIGN DETAILS

FHWA REGION	STATE	F.C. & P. No. N.C.	SHEET NO.
8	N.D.	F-1-094(03)	98

D 754 - 3

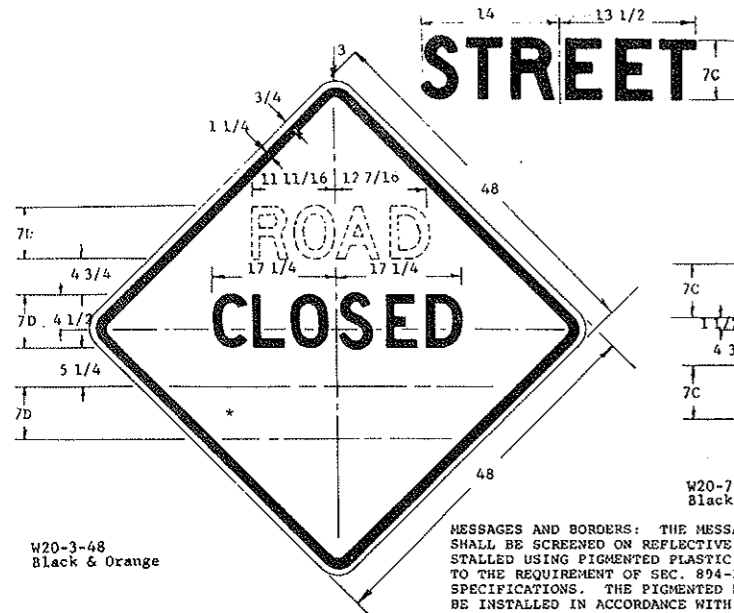

W20-7-48  
Black & Orange

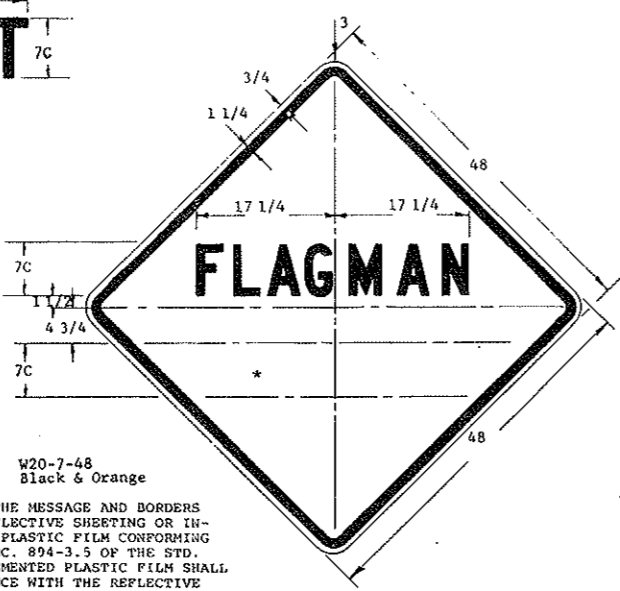

W21-2-48  
Black & Orange

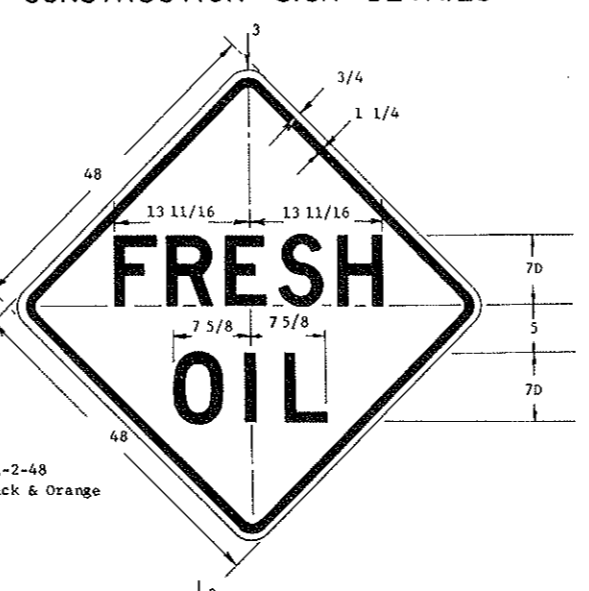

W21-5-48  
Black & Orange

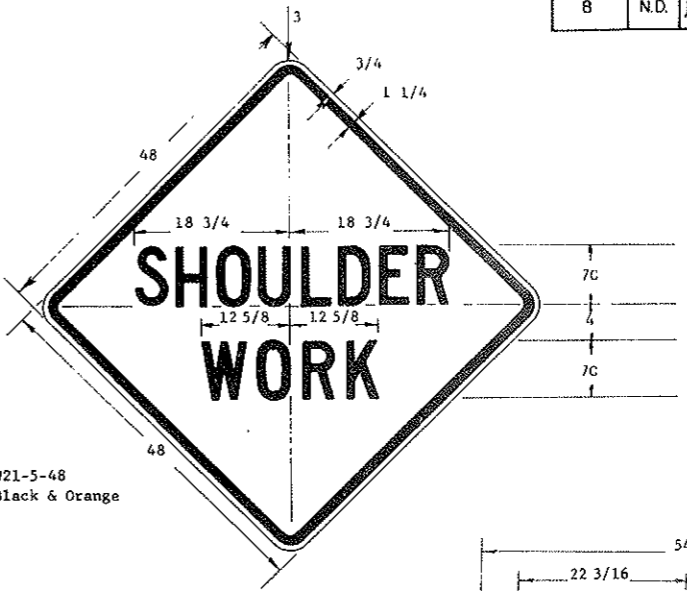

MESSAGES AND BORDERS: THE MESSAGE AND BORDERS SHALL BE SCREENED ON REFLECTIVE SHEETING OR INSTALLED USING PIGMENTED PLASTIC FILM CONFORMING TO THE REQUIREMENT OF SEC. 894-3.5 OF THE STD. SPECIFICATIONS. THE PIGMENTED PLASTIC FILM SHALL BE INSTALLED IN ACCORDANCE WITH THE REFLECTIVE SHEETING MANUFACTURERS RECOMMENDATIONS. THE BORDERS SHALL HAVE THE RADI AND WIDTH SHOWN ON THE PLANS. THE LETTERS SHALL BE FABRICATED IN ACCORDANCE WITH THE STANDARD LETTER GUIDE OF THE HEIGHT AND SERIES SHOWN ON THE PLANS. THE DETAILS OF THESE LETTERS MAY BE OBTAINED FROM THE STATE HIGHWAY DEPARTMENT OR THE SHEETING MANUFACTURER.

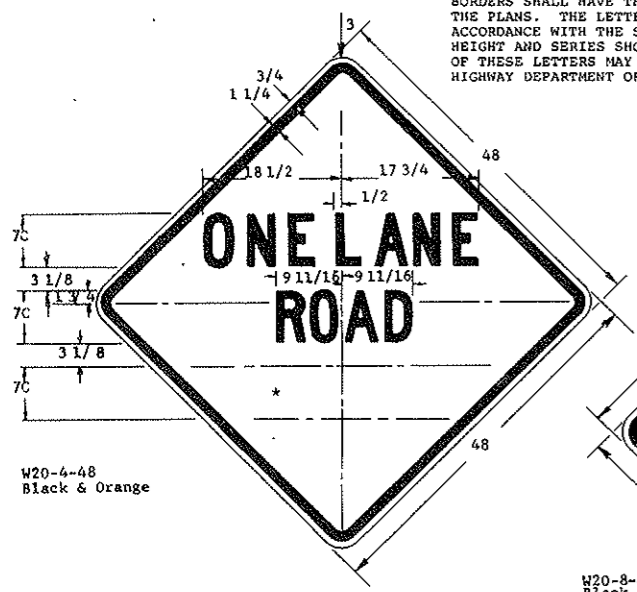

W20-4-48  
Black & Orange

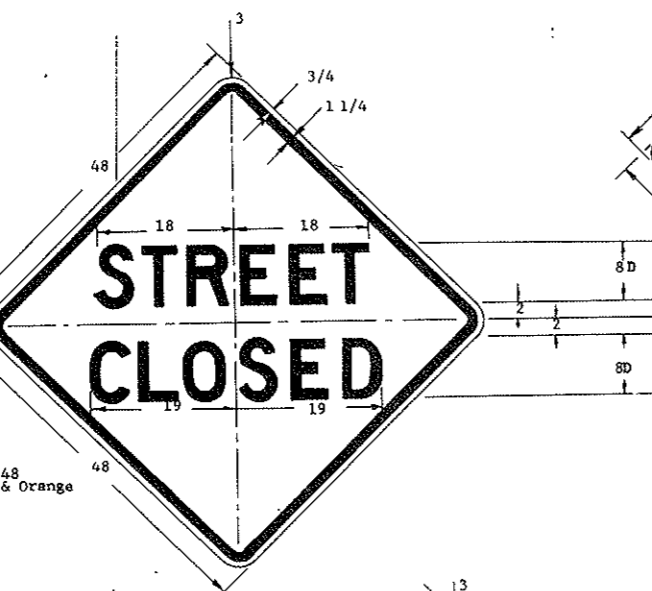

W21-3-48  
Black & Orange

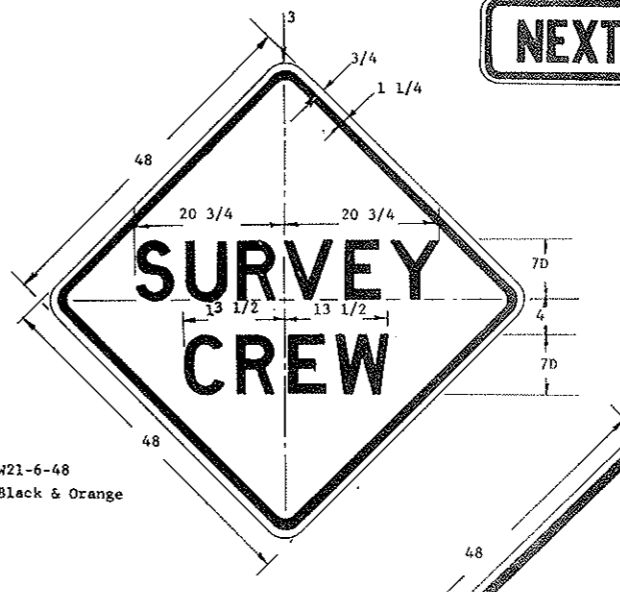
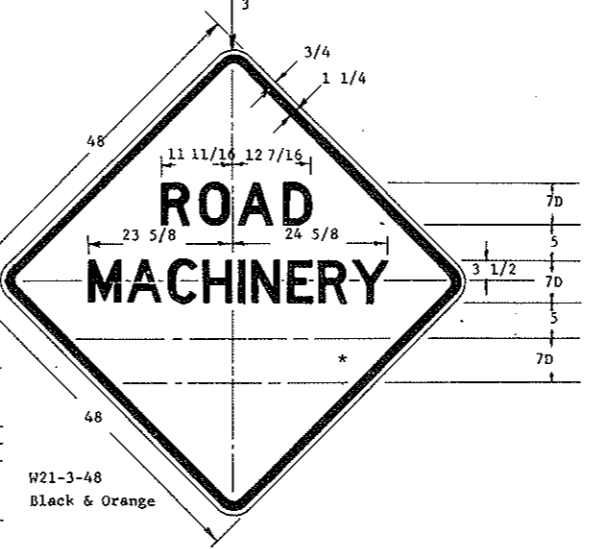

W21-6-48  
Black & Orange

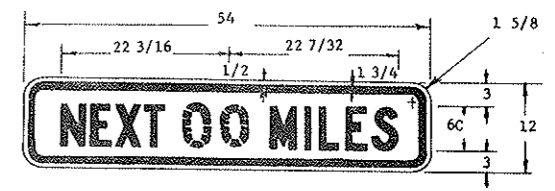

W22-6a-54  
Black & Orange

NOTE: ALL SIGNS SHALL HAVE REFLECTORIZED MESSAGE BORDER AND BACKGROUND, UNLESS SHOWN OTHERWISE ON THE PLANS. IN NO CASE IS THE COLOR BLACK REFLECTORIZED.

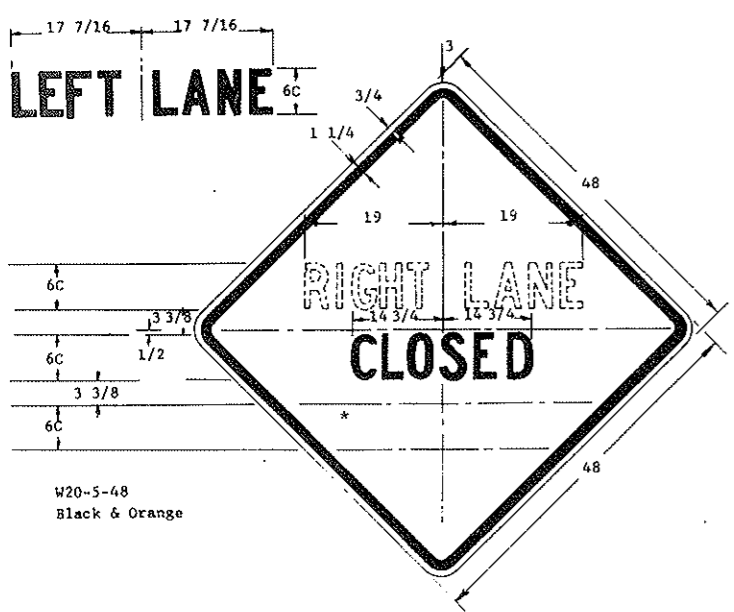

W20-5-48  
Black & Orange

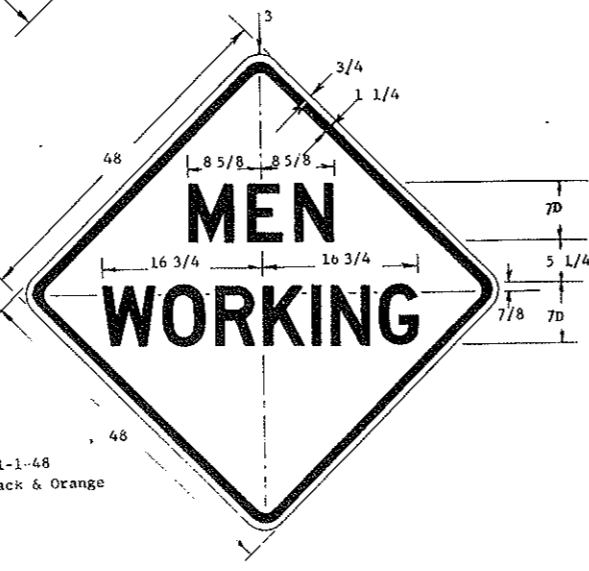

W21-1-48  
Black & Orange

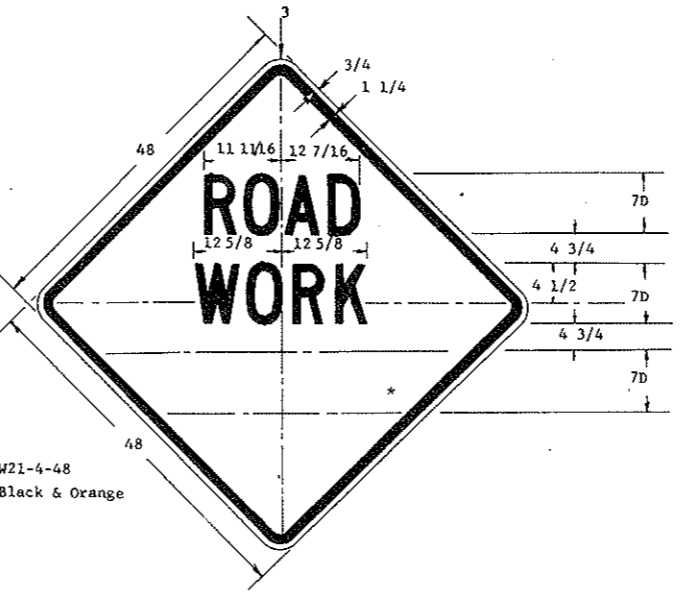

W21-4-48  
Black & Orange

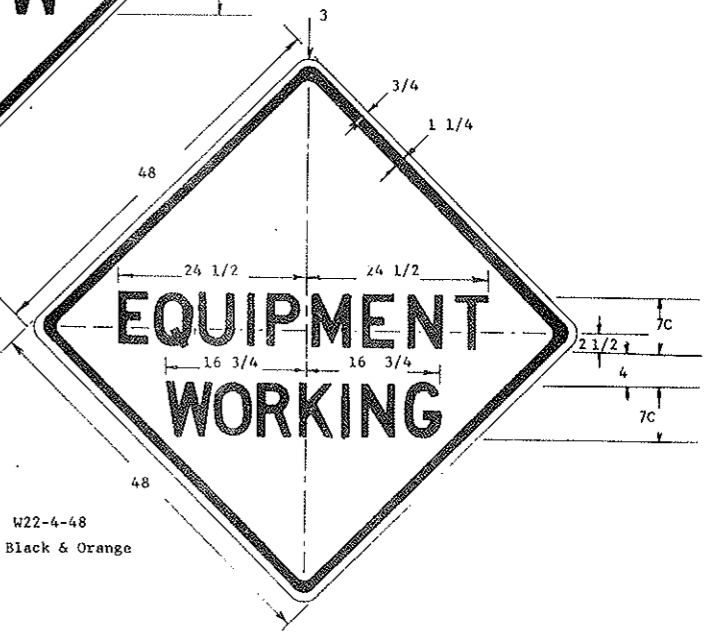

W22-4-48  
Black & Orange

2-17-78		NORTH DAKOTA STATE HIGHWAY DEPARTMENT
REVISIONS		
DATE	CHANGE	Submitted: <i>[Signature]</i> Design Engineer
		Recommended: Asst. Chief Engineer, Pre - Constr.
		Approved: <i>[Signature]</i> Chief Engineer