

DESIGN DATA

Traffic	Average Daily	Est. 30th Max. Hr.
Current Traffic (1986)	19000 Pass. 1000 Trucks 20,000 Total	2000
Traffic Forecast (2006)	24700 Pass. 13000 Trucks 28,000 Total	2600
Design Speed	35 MPH	
Traffic Classification "M"		
Minimum Sight Distance (Stopping)	250'	

NORTH DAKOTA
STATE HIGHWAY DEPARTMENT

MORTON COUNTY
F-1-094(006)915

FHWA REGION	STATE	PROJECT	SHEET NO.
8	N.D.	F-1-094 (006)915	1

GOVERNING SPECIFICATIONS
Standard Specifications adopted by the North Dakota State Highway Department, November 1986. Standard Drawings currently in effect, and other Contract Provisions submitted herein.

PRELIMINARY

Date 2-9-87

P.S. & E. FEB. 19TH. - 8:30 A.M. @ CITY HALL
IN MANDAN

This project consists of 1.3 miles of urban construction. 0.7 miles is complete reconstruction including P.C.C. Pavement, Curb and Gutter, and Concrete Sidewalk. 0.6 miles is concrete pavement repair. There is also street lighting, signing, pavement marking, and some storm sewer work.

LENGTH OF PROJECT

Miles-Gross	Miles-Net
1.463	1.302
(0.151 Mi. Deducted for Exception)	

NOTE: PLANS FOR STREET LIGHTING, TRAFFIC SIGNAL REVISIONS, SIGNING, AND PAVEMENT MARKING ARE NOT INCLUDED. THESE WILL BE AVAILABLE AT A LATER DATE

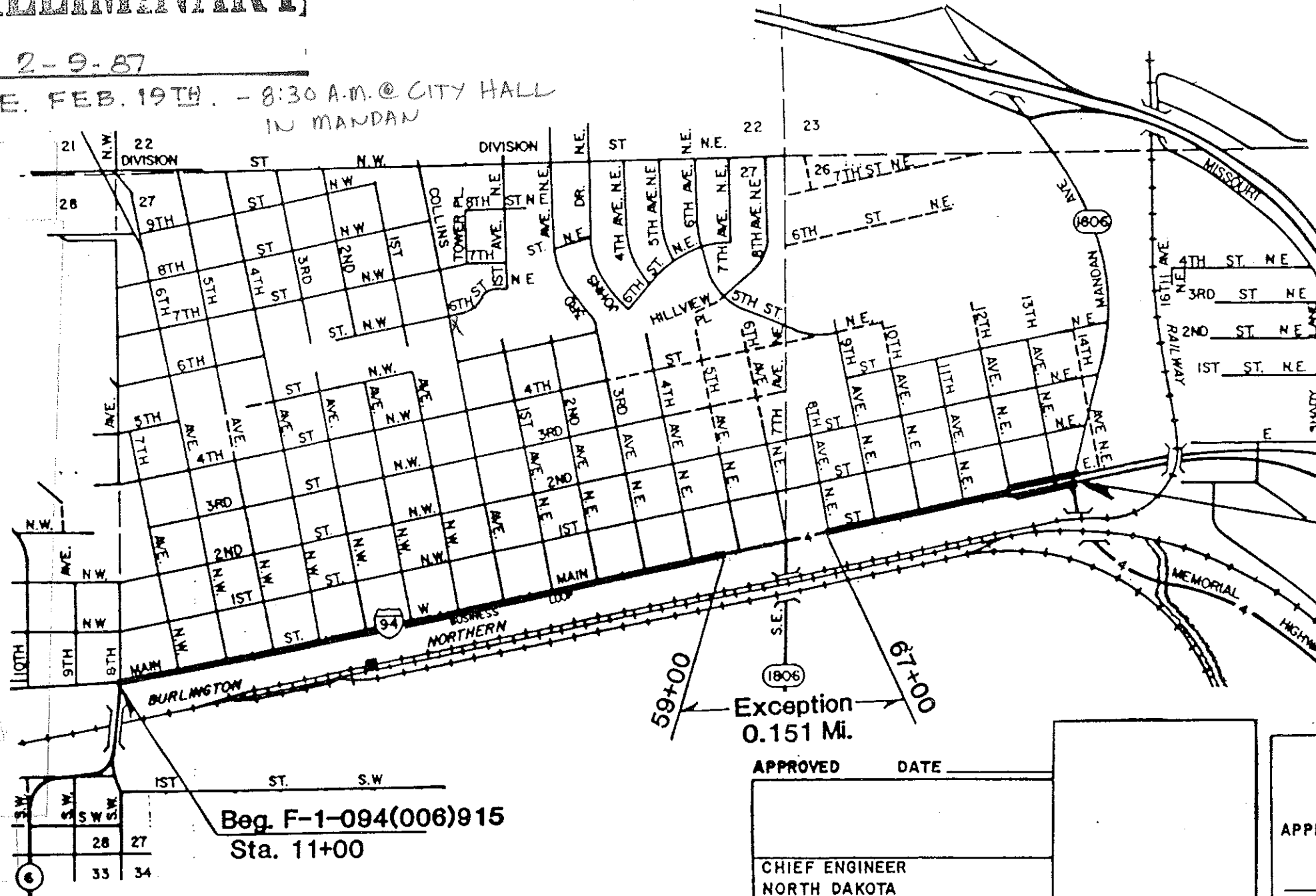

MANDAN

Sec. 26 & 27,
T. 139 N.
R. 81 W.

End F-1-094(006)915
Sta. 88+26

Req. F-1-094(006)915
Sta. 11+00

APPROVED _____ DATE _____

CHIEF ENGINEER
NORTH DAKOTA
STATE HIGHWAY DEPARTMENT

U.S. DEPARTMENT OF TRANSPORTATION
FEDERAL HIGHWAY ADMINISTRATION

APPROVED **16**

DIVISION ENGINEER _____ DATE _____

GENERAL NOTES

FHWA REGION	STATE	FED. AID PROJ. NO.	SHEET NO.
8	ND.	F-1-094(006)915	-

1/2 Lights operation and Traffic Signals operation 1. 6. 2. 8.

100 GENERAL: The engineer will attend to the removal of existing
011 fences to the highway right of way line and to the relocation or
adjustment of utility facilities as shown on the plans. Equipment
shall work around utility poles, within the area, that are not
to be disturbed.

100 Cross sections for this project are available for inspection at
014 the Design Division, North Dakota State Highway Department, 600
East Boulevard Avenue, Bismarck, North Dakota 58505-0178 and also
at the North Dakota State Highway Department District Office in
Bismarck, North Dakota.

100 WORK SCHEDULE: In order to minimize interference with traffic
020 operations, a detailed schedule shall be agreed to prior to
beginning work, between the engineer, utility companies, and the
contractor and subcontractors, if any.

100 UNDERGROUND UTILITIES: The contractor shall notify the local
030 utility companies prior to the beginning of construction, so they
may stake location and depth of all utilities in the project
area. Subcutting or scarifying over utility lines may be
eliminated if, in the opinion of the engineer, a hazardous
situation exists. Separate plans, if any, showing relocation or
adjustment work to be performed by utility companies to
accommodate highway construction will be made available to the
contractor, upon request to the engineer.

~~100 DETOURS: The contractor shall maintain the streets used as
060 detours (streets to be designated by the engineer) and repair
areas damaged by the detoured traffic. Upon completion of the
project, the contractor shall restore the streets to a condition
at least equal to that which existed at the time traffic was
routed over them. Work shall be as deemed necessary by the
engineer. The repair and maintenance of the detours will be paid
for in accordance with Section 107.05 B of the Standard
Specifications - Haul Roads. Necessary route markers will be
furnished by the State Highway Department and erected and
maintained by the contractor as an incidental item.~~

100 The contractor will be required to conduct the construction
133 activities in such a manner as to comply with the Air Pollution
Control Regulations of the state of North Dakota. Water will
be used to control dust on the construction site.

100 CONTRACTOR-OPTIONED PITS: Prior to surface disturbance or
145 removal of aggregate from a contractor-optioned pit, the
contractor shall provide the North Dakota State Highway
Department with a description of the location of the pit. The
North Dakota State Highway Department will submit this
information to the State Historic Preservation Officer for review
to see if any significant cultural resources would be affected.
The contractor shall submit this information to the North Dakota
State Highway Department at least seven days prior to stripping
the surface or removing any aggregate from the pit. Apart from
extension of time, no payment or claim for any damages shall be
made to the contractor as compensation for damage for any delays
or hindrances from any cause whatsoever in the progress of the
work because of this required review.

100 REQUIRED CONSTRUCTION SEQUENCE: Prior to June 20, 1987, the
P01 only construction that will be allowed is the underground work
(storm sewer, etc.) from 8th Avenue, NW to 2nd Avenue, NE and the
concrete pavement repair from 2nd Avenue NE to Mandan Avenue. A
temporary patch consisting of 3 inches of cold bituminous pavement
shall be installed in the areas where the concrete pavement is
removed to allow for the installation of the storm sewer.

No other concrete pavement removal or concrete sidewalk removal
will be permitted until July 6, 1987. Between June 29, 1987, and
July 6, 1987, the roadway must be opened for the full and
unobstructed use of traffic. No work on the roadway will be
permitted during this period without written consent of the
highway department engineer.

From 8th Avenue NW to 2nd Avenue NE, the contractor will be
required to complete the installation of the concrete pavement
on the north half of the roadway prior to the concrete removal
and reconstruction on the south half of the roadway. The
Contractor will be allowed to remove up to 2½ feet of the
existing concrete sidewalk when the curb and gutter and/or the
integral curb is removed to allow sufficient room for the
placement of the new concrete surfacing and curb and gutter.
When the contractor begins to remove the remainder of the
sidewalk, he will not be permitted to remove any more than can be
replaced by the end of the following day.

Two-way traffic will be maintained on Main Street during
construction. On-street parking will be prohibited in the areas
where the traffic control requires the use of the parking lanes
for maintaining the two-way traffic.

When the intersecting avenues are closed for construction, the
contractor will not be permitted to close consecutive
intersections. Approaches to all business places shall be
maintained on an all-weather surface ~~at all times~~ (minimum
3 inches cold bituminous pavement).

GENERAL NOTES

FHWA REGION	STATE	FED. AID PROJ. NO.	SHEET NO.
8	N.D.	F-1-094(006)915	

100 WEEKLY PLANNING/REPORTING MEETING:
P02

- A. Purpose of Weekly Meeting.
1. Coordination of efforts between subcontractors, utilities, local authorities, and others.
- B. Contractor's Project Manager/Superintendent: Planning and Reporting.
1. The contractor will be required to provide a written schedule of the next weeks work and a tentative schedule of the following week.
 2. The contractor will be responsible for sending a knowledgeable representative to conduct a weekly Reporting/Planning meeting.
 3. Reporting/Planning meeting will include discussion of problems encountered during the current week; information of interest to local authorities, subcontractors, utilities, and next weeks prospective schedule.
 4. The contractor will organize the weekly meeting contacting interested agencies. These agencies include but are not limited to the following:
 - a. State Highway Department.
 - b. City Engineer's representative.
 - c. Police department.
 - d. Fire department.
 - e. Ambulance service.
 - f. Telephone Co.
 - g. MDU.
 - h. Cable TV.
 - i. Subcontractors.

200 SHRINKAGE: 20 percent additional volume in yardage computed by
010 the end area method is allowed for shrinkage in earth embankment.

200 PAVEMENT REMOVAL: All concrete and pavements paid for as removal
060 shall be deducted from the excavation quantity.

200 REMOVAL OF CONCRETE PAVEMENT: From 8th Avenue NW to 2nd Avenue NE
P01 the removal of existing concrete driveways, concrete street approaches and the main line concrete pavement (including the curb and gutter and/or the integral curb) shall be measured and paid for at the contract unit price per square yard for "Removal of Concrete Pavement."

200 REMOVAL OF CONCRETE: From 8th Avenue NW to 2nd Avenue NE the
P02 removal of the existing sidewalk and any other surface concrete items, other than the concrete pavement and driveways mentioned in the previous note, shall be measured and paid for at the contract unit price per square yard for "Removal of Concrete". From 2nd Avenue NE to end of project, the removal of the existing curb and gutter and concrete sidewalk as required for the construction of the new curb ramps has been included in the quantities and shall be paid for at the price bid for "Removal of Concrete".

200 WATER: The cost of the water required for compaction, for the
P03 aggregate base course and for use as a dust palliative, has been included in the quantities and shall be paid for at the unit price bid for "Water".

200 COMPACTION AND DENSITY CONTROL: Compaction and density controls
360 shall be in accordance with Section 203.02 F of the Standard Specifications T-180.

200 SUBCUT SCARIFY AND RECOMPACT: The roadway between Sta. 11-00 and
P04 48+57 shall be subcut to a distance of one foot outside the curb lines and to the depth shown on the plan and profile and cross section sheets. ~~The next one foot shall be scarified and recompact.~~ The subcut section shall be brought back to the proposed grade line with Class 5 aggregate base. The contractor shall have the option of crushing the concrete removed on this project and using this material for a portion of the backfill in lieu of the aggregate base. The crushed concrete (if used) shall have a maximum size of 3/4 inches and 10 percent or less of the material passing the No. 200 sieve. If the contractor elects to use crushed concrete, this material shall be measured and paid for at the unit price bid for "Aggregate Base Course - Class 5".

From Sta. 48+57 to 88+26 where the plans call for full depth repair of the existing concrete pavement, the subgrade below the pavement repair sections shall be subcut to the following depths:

48+57 to 62+00 - 2.0 Ft.
62-00 to 79+00 - 3.0 Ft.
79+00 to 88-26 - 2.0 Ft.

~~The next one foot below the subcut shall be scarified and recompact.~~ The subcut section shall be brought back to grade with Class 5 aggregate base or crushed concrete as stated above. The subcut has been included in the quantities and shall be paid for at the unit price bid for "Common Excavation - Type A". The cost of scarifying and recompacting shall be included in the price bid for "Common Excavation - Type A".

GENERAL NOTES

FHWA REGION	STATE	FED. AID PROJ. NO.	SHEET NO.
8	N.D.	F-1-094(006)915	-

200 P05 EXCESS EXCAVATION: The excess excavation shall be stockpiled within the right of way limits at the location shown on the "Waste Area Haul Road" sheet. The exact location and the dimension for the stockpile will be determined by the Engineer.

Approximately 6 inches of the existing topsoil shall be removed prior to placement of the excess excavation. When the placement of the excess excavation is completed, the topsoil shall be replaced on the stockpile and the entire area seeded. All other areas (including cartways) disturbed by this stockpiling shall also be seeded. Five acres of Class V, Type B Seeding has been provided for this purpose. The Class V seed mixture shall consist of Brome Grass and Crested Wheat Grass in a 50/50 mixture. The removal, stockpiling, and replacement of topsoil (approx. 1500 C.Y.) shall be measured and paid for at the unit price bid for "Topsoil - Waste Area".

Trucks hauling the excess excavation must exit and enter the roadway at a location approved by the Engineer. It may be necessary to construct a temporary access approach at this location.

All hauling, construction, and removal of access approach, repair of bituminous shoulder, (if required) restoration of cartways, shaping of stockpile, and other items associated with the disposal of the excess excavation shall be included in the price bid for "Common Excavation - Type A".

200 P06 DISPOSAL OF CONCRETE: If the existing concrete (pavement, sidewalk, curb and gutter, driveways, etc.) is not crushed and used in the subgrade (see Note 200-P04) it shall be disposed of at a site obtained by the contractor and approved by the engineer. Disposal in a wetland area will not be permitted. Cost of this disposal and obtaining of a disposal area, shall be included in the price bid for the items, "Removal of Concrete" and "Removal of Concrete Pavement".

200 P07 REMOVAL OF CATCH BASINS AND MANHOLES: At locations shown in the plans for "Removal of Catch Basins" and "Removal of Manholes", the work shall be performed in the following manner. The contractor shall carefully remove the existing castings and deliver them to the city shop at 6th Avenue SW. The concrete barrel or box shall then be removed or obliterated to a minimum of one foot below the aggregate base. If the existing sewer pipes are no longer required for drainage, they shall be removed or thoroughly plugged at the ends. The resulting holes shall be filled with Class 5 aggregate base. Removal of curb inlets has been included in the quantities and shall be paid for at the unit price bid for "Removal of Catch Basins."

200 P08 HEATED SIDEWALK: In front of the "All Building" located at the NE corner of Main Street and 3rd Avenue NW (Approximately Sta. 30+) and in front of Thomas TV and Appliance store located at approximately Sta. 35+ Rt., the existing sidewalks are heated. When the contractor removes the existing sidewalk in these areas, the city will arrange to have the heating elements either reset or replaced before the new sidewalk is installed. The contractor shall use care when removing the existing sidewalk and shall coordinate his work in these areas with the Mandan City Engineer. All costs associated with the resetting or replacing of these heating elements shall be the responsibility of the city of Mandan.

400 P01 COLD BITUMINOUS PAVEMENT: 400 Tons of Cold Bituminous Pavement has been provided and shall be used for maintaining traffic at designated driveway locations, for patching sewer trenches (Note 100-P01), and for patching on intersecting street approaches where the new concrete surfacing abuts the existing bituminous surfacing. The depths of cold bituminous pavement shall be a minimum of 3" on the driveways and sewer trenches and 8" on intersecting streets. The exact locations and quantities shall be determined in the field. The gradation of the aggregate and the type and grade of bitumen to be used shall be approved by the engineer. The unit price for "Cold Bituminous Pavement" will be full compensation for all labor, equipment, and materials (including bitumen) necessary to complete the work as specified. Subsequent removal of this material (where required) will not be paid for separately but shall be included in the price bid for "Cold Bituminous Pavement".

550 P01 HIGH EARLY STRENGTH CONCRETE: All concrete driveways on this project shall be constructed with high early strength concrete. 1800 S.Y. of 8 in Non-reinforced Concrete Pavement - High Early Strength has been included in the quantities and shall be used to construct street approaches and to complete the surfacing of "gaps" left in the concrete pavement for traffic control. The exact locations, use, and quantity of high early strength pavement shall be determined by the engineer in the field.

550 P02 MANHOLE BLOCKOUTS: All manholes located in the new 8 inch concrete pavement shall be blocked out as shown on the manhole blockout detail sheet. The blockouts will not be paid for separately but shall be included in the price bid for "8 in. Non-reinforced Concrete Pavement - Class AE".

GENERAL NOTES

FHWA REGION	STATE	FED. AID PROJ NO	SHEET NO
8	N.D.	F-1-094(006)915	

704 TRAFFIC CONTROL:
P02

- A. The contractor shall provide a qualified traffic maintenance person with the following minimum qualifications:
1. This person shall:
 - a. Have completed a course of study based on the MUTCD and furnish proof.
 - b. Be conversant with the contents and intentions contained within the MUTCD and the NDSHD Specifications.
 - c. Have previous experience working with maintenance and protection of traffic.
 - d. Be competent to supervise personnel with lessor training in traffic maintenance operations.
 - e. Be present on the project on a daily basis unless released by the engineer.
 2. Duties:
 - a. To provide traffic control as required by the plans, Standard Specifications, Special Provisions, or MUTCD, or as directed by the engineer.
 - b. The traffic control person shall provide documentation of each day's inspection results and remedial activities.

704 MAINTAINING ACCESS: The contractor will be responsible for
010 providing access to all residential dwelling and business establishments adjacent to this project. Final details on location of access points and construction procedures shall be worked out with the engineer in the field prior to start of the project.

706 FIELD LABORATORY: If deemed unnecessary by the engineer in the
010 field, the item "Field Laboratory" shall be deleted.

708 SODDING: Sodding quantities have been provided to sod
010 construction areas where the adjacent property has sod established. Sodding locations will be determined by the engineer.

The price bid for "Safety Fence" shall be full compensation for all labor, equipment, and materials necessary to complete the work as required.

714 ADJUST WATER AND SEWER LINES: The exact depth of the existing
020 water and sewer lines under the roadway is unknown. If it is determined in the field that adjustment or relocation of these lines is necessary to facilitate the new construction, such work shall be done in accordance with Sec. 109.04 of the Standard Specifications, "Extra Work."

714 DRAINAGE: If the existing drainage facilities become inoperable
040 before the new drainage system is functioning, the contractor shall provide sufficient temporary pumping and drainage facilities to keep the roadway drained to the satisfaction of the engineer. Not a pay item, cost to be incidental to the price bid for other items.

722 INLET AND MANHOLE CASTINGS: The price bid for "Inlet, Curb
P01 Casting" and "Manhole Casting" shall include the removal of the existing castings and the furnishing, installing, and adjustment to grade of the new castings. Old castings shall be delivered to the city shop at 6th Avenue SW

722 STORM DRAINS: At locations shown in the plans, new sewer is to
P02 be installed into existing manholes or new inlets and new manholes or inlets are to be installed over existing sewers. The cost of cutting into the inlets or manholes, removing and replacing sewer, grouting, and other work required to complete these installations shall be included in the price bid for other items.

722 SPECIAL INLETS: The price bid for "Special Inlets" will be full
P03 compensation for all labor, equipment, and materials (including 48" riser) required to complete the work as specified.

750 INSTALLATION OF CONCRETE SIDEWALK: When installing the new
P01 sidewalk, the contractor will be required to work around and/or adjacent to existing steps, window wells, canopy supports, building fronts, signs, poles, etc. Extreme care will be required to prevent damaging these items that will be remaining in place.

750 CURB RAMPS: The location for the curb ramps shown on the plan
P02 and profile sheets is advisory only. The exact location and type of ramp shall be determined by the engineer in the field after consultation with the Mandan City Engineer and changes made accordingly.

752 SAFETY FENCE: A temporary pedestrian safety fence shall be installed
P01 between the existing sidewalk and the roadway when, in the opinion of the Engineer, the construction procedures represent a hazard to pedestrians. The fence shall remain in place as long as a hazard exists or as required for pedestrian control. The safety fence shall be orange in color, 4-feet high, and constructed of high density polyethylene and shall be installed in accordance with manufacturers recommendations. Tensor Corporation fence product no. UX 4050 or equal can be used. The quantity of fencing shown is advisory only and the actual amount needed shall be determined in the field as required for the construction sequencing.

FHWA REGION	STATE	FED. AID PROJ NO	SHEET NO
8	ND.	F-1-094(006)915	

GENERAL NOTES

(CONCRETE PAVEMENT REPAIR & JOINT REPAIR - FULL DEPTH)
(SPALL REPAIR - PARTIAL DEPTH)
(STA. 48+57 to 88+26)

550 REMOVAL OF EXISTING CONCRETE: Except where joints form the edge
100 of the repair, the edges of the repair area shall be sawn full
depth with a diamond or carborundum blade as shown on plan
details. If the full depth cuts are made in more than one pass,
the final full depth cut shall be made immediately following the
partial depth cuts. The transverse saw cuts shall be made
perpendicular to the centerline, except where fixed joints are
used on repairs 8 feet or less in length (see joint repair
details). On single lane repairs, saw cuts which extend into the
concrete which will remain, shall be only long enough to guarantee
a full depth cut of the repair area and shall be sealed with a
non-shrinking mortar material. The concrete shall be removed
within 24 hours of the transverse sawing. When the repair area is
prepared, the edges shall be reasonably free of frays or spalls at
the pavement surface.

1.) Full depth repairs that are eight feet (8') or less in the
longitudinal length, shall be removed by the lift-out method.
Damage to the face of any concrete to remain in place will not be
permitted. To facilitate removal, after the initial patch
boundary saw cuts have been made, additional saw cuts may be made
with a saw other than a diamond or carborundum type saw within the
patch limits but the saw shall not penetrate more than one inch
into the subgrade.

2.) Full depth repairs that are more than eight feet (8') in the
longitudinal length, may be removed by the break-in-place
method. If this method is used, breaking of the concrete shall
be kept a minimum of two feet (2') from the edge of the repair
area. A hydro-hammer or other heavy equipment may be used
provided the equipment is not used within two feet (2') from the
edge of the repair area. Heavy equipment shall not be used
adjacent to concrete that has been in place less than 48 hours.

3.) The contractor may submit alternate methods of removal which
may be used if written approval is granted from the engineer.

4.) The cost of removing, hauling, and disposing of existing
concrete and sealing saw cut over runs shall be included in the
unit price bid for full depth repair items.

550 EXISTING BITUMINOUS PATCHES: The existing bituminous material
120 used for patching concrete pavement, where partial or full depth
repair is to be done, shall be removed and disposed of by the
contractor. Cost for this work shall be included in the unit
price bid for other items.

550 DISPOSAL OF WASTE MATERIAL: The contractor shall obtain the
140 disposal area and written approval from the land owner. The
disposal site shall be subject to the approval of the engineer.
Disposal in wetland areas will not be approved. Cost for this
work will not be paid for directly but shall be incidental to the
price bid for other items. (See Note 200-P05 and 200-P06)

550 DOWEL BARS FOR TRANSVERSE JOINTS AT FULL DEPTH REPAIRS (LOAD
170 TRANSFER): This item of work shall consist of drilling holes and
installing 1½"x18" smooth dowel bars (Grade 40) and #9x18"
deformed bars (Grade 40) in the face of the existing slab where
indicated by the joint repair and concrete pavement repair detail
sheets. Drills shall be mounted on a rigid frame to provide
proper position and alignment. The holes shall be a maximum of
1 3/8" diameter. They shall be located at mid-depth of the slab
and spaced as indicated on the plans.

A high-viscosity epoxy meeting the requirements of AASHTO M-235
shall be used to anchor the bars in the hole. The holes shall be
brushed with a stiff nylon brush and blown clean with compressed
air applied to the back of the hole before applying the epoxy.
The epoxy shall be applied to the back of the hole thus allowing
the air to escape and the epoxy to flow forward toward the joint
face as the bar is inserted. The holes should be completely
filled around the bars to insure that they are permanently
fastened to the existing concrete. A small temporary form shall
be applied to the face of the hole to keep the epoxy from flowing
out. The form shall be removed prior to concrete placement.

The smooth dowel bars shall be carefully aligned with the
direction of the pavement and parallel to the plane of the
surface in order to provide free movement. The maximum allowable
tolerance for misalignment shall be 1/8 inch per foot vertically
and horizontally. The end of each smooth dowel bar extending
into the patch shall be given a light coating of grease to
provide free movement. Excess grease shall not be permitted.
Other suitable bond breaking material can be used besides grease
but shall be subject to the approval of the engineer.

The unit price bid for the item "Dowel Bars" shall be considered
full compensation for all work, labor, materials, and costs
incurred by installing dowel bars - smooth or deformed.

FHWA REGION	STATE	FED AID PROJ. NO.	SHEET NO.
8	N.D.	F-1-094(006)915	

GENERAL NOTES

(CONCRETE PAVEMENT REPAIR & JOINT REPAIR - FULL DEPTH)
(SPALL REPAIR - PARTIAL DEPTH)
(STA. 48+57 to 88+26)

550 PORTLAND CEMENT CONCRETE REPAIRS AND SPALL REPAIR - PARTIAL
180 DEPTH: The Portland Cement concrete for both spall repairs and full-depth repairs shall be a 7.4 bag mix with a maximum water content of 4.75 gal./bag of cement. The cement used for repair work shall be Type III cement that meets the requirements of AASHTO M85.

The coarse aggregate for spall repair may be size 4 or 5 at the option of the contractor. The coarse aggregate for concrete used for all full-depth repair may be size 3, 4, or 5 at the option of the contractor.

Water reducing and set acceleration may be achieved through the use of a commercial admixture which meets AASHTO Specification M-194 Type A, C, or E.

550 FORMS FOR P.C.C. REPAIRS: Forms shall be used on all exposed
200 edges. For full depth repairs that are 8' or more in the longitudinal length, steel forms shall be used. Wood forms may be used in lieu of steel for full depth repairs that are less than 8' in the longitudinal length. When wood forms are used, the forms shall consist of two-inch lumber, the full depth of concrete on the outside edge and shall be continuous through the length of the repair. Placement of forms shall be in accordance with applicable provisions of Section 550-04 G.2. Full depth concrete patches that are more than 8' in longitudinal length shall be finished with a commercially manufactured screed capable of providing the finish and ride as specified in Section 550, with limited hand work required.

550 PLACING PORTLAND CEMENT CONCRETE: Placing of concrete in full
210 depth repairs shall be performed within 24 hours of the removal of the concrete. On full depth repairs longer than 100 feet longitudinally, concrete shall be placed within 48 hours after the sawing for removal has begun. Placing, consolidating, finishing, and curing of the concrete shall be as provided in Section 802 except as follows: Concrete shall not be placed in the repair areas before 10:00 a.m. or as allowed by the Engineer, to allow the adjacent concrete to reach its maximum expansion. Concrete shall not be placed prior to May 1 and not after September 15 unless authorized in writing by the Engineer. The faces of the old concrete around the section to be replaced shall be wetted with water before the new concrete is placed. The concrete shall be dumped or conveyed into the repair area in such a way that there will be no segregation of the aggregates and cement, and then spread into place, vibrated with a mechanical vibrator, and smoothed. Excessive vibrating shall be avoided. Concrete shall be finished flush with the adjacent pavement surface and shall be straight edged to ensure a smooth riding surface, and shall be textured longitudinally by finishing with a carpet type or Astro grass Drag, the intention being to recreate

the texture of the adjacent surface. Repair areas over ten feet in length shall be checked by the contractor with 10 foot straight edge before the concrete has set, and spots that are 1/8 inch high, or low, as shown by the straight edge, shall be corrected. Repair areas that do not meet the surface tolerances shall be corrected as specified in Section 550.04 P.1.

550 REPAIR SIZE AND LONGITUDINAL JOINT TREATMENTS: Minimum size
220 joint repair (full-depth) shall be four feet by twelve feet. Repair areas four to eight feet in longitudinal length will be placed using a full-depth centerline bond breaker such as a thickness of bituthene and no centerline steel tie will be required. When a ramp or taper is encountered, the longitudinal joint between the mainline and the ramp shall be restored but the tie bars in that joint shall not be re-established. When a one-lane repair extends beyond the limits of the original transverse joints, centerline tie bars shall be omitted either side of the existing transverse joint until the first intermediate joint is encountered. See full-depth details.

Full-depth full-width repair areas will be replaced in two halves using the centerline treatment as follows:

a. After placing the first pour, the centerline gap between the first pour and the existing concrete shall be filled with cold bituminous material to prevent the infiltration of water. This material shall be removed before the second pour is made. The cost for providing and removing the cold bituminous material shall be included in the price bid for full-depth repair.

b. Centerline joint steel, on repairs exceeding 8' in length, will be treated as follows:

1. Each half of existing bars may be exposed independently and repoured to leave the existing bar in its original location.
2. "J"-Bolts or new #5 x 2'-6" tie-bars may be installed in the joint before the second half of the repair area is poured to establish the original tie-bar pattern and steel cross-sectional area. If the contractor chooses to install new tie-bars, the tie-bars shall be installed by drilling and grouting with a high-viscosity epoxy meeting the requirements of AASHTO M-235.

FHWA REGION	STATE	FED AID PROJ NO	SHEET
8	ND.	F-1-094(006)915	

GENERAL NOTES

(CONCRETE PAVEMENT REPAIR & JOINT REPAIR - FULL DEPTH)
(SPALL REPAIR - PARTIAL DEPTH)
(STA. 48+57 to 88+26)

550 REINFORCING STEEL: The cost for all steel used for reinforcing,
230 bar supports, J-bolts, and tie bars will not be a separate pay
item but shall be incidental to the price bid for "Joint Repair -
Full Depth" and Concrete Pavement Repair - Full Depth."

550 TRANSVERSE JOINTS: The transverse joints at each end of a full
260 depth repair shall be sawed. At those locations where full-depth
slab repair exceeds 20 feet in length, intermediate transverse
joints shall be sawed at a random spacing of 12- to 15-foot
spacing. The time and sequence of sawing shall be adjusted so
that all joints will be cut within 12 hours and before
uncontrolled cracking occurs, but not until the concrete has
hardened sufficiently to permit sawing without excessive
raveling. Cost for sawing intermediate joints and transverse
joints at each end of a full depth repair will not be paid for
directly, but shall be considered as an incidental item to the
full depth repair items.

550 CURING AND OPENING TO TRAFFIC: On full-depth repairs and spall
270 repairs, a liquid membrane cure shall be applied in accordance
with Section 550.04 K.3 immediately after texturing of the
concrete. An approved type of hand operated sprayer may be used
to apply the curing compound. The minimum rate of application
shall be one gallon per 150 square feet. Partial depth repairs
shall be cured for 24 hours prior to opening to traffic.
Full-depth repairs shall be cured and not opened to traffic for a
minimum of 30 hours or until the concrete attains a compressive
strength of 2500 psi. The maximum required closure time shall be
7 days.

550 DAMAGED AREAS: Any repair areas that are damaged in any manner
280 during the curing period shall be replaced by the contractor at
his expense. If a repair area needs to be lengthened due to
damage caused by the contractor's operation, the repair of the
lengthened portion shall be at the contractor's expense.

550 METHOD OF MEASUREMENT: Joint Repair (full-depth) that is 8 feet
300 or less in length will be measured by the square foot of the area
of repair as specified and accepted by the engineer.

550 METHOD OF MEASUREMENT: Concrete Pavement Repair (full-depth)
310 that is more than 8 feet in length will be measured by the square
yard of the area of repair as specified and accepted by the
engineer. If a Joint Repair (full-depth) is extended beyond 8
feet in length, that portion of the extension beyond 8 feet shall
be paid for as Concrete Pavement Repair.

550 BASIS OF PAYMENT: The full-depth repair quantities measured, as
320 specified, will be paid for at the contract unit price. This
price will be considered full compensation for all work performed
and all labor, materials, and costs incurred by this work.

550 QUANTITIES: The quantities for Concrete Pavement Repair (Full
P10 Depth-Doweled), Joint Repair (Full Depth-Doweled), Random P.C.C.
Crack Cleaning and Sealing, and Spall Repair (Partial Depth)
have been increased by 10 percent to allow for the additional
pavement distress that has occurred since the concrete pavement
condition survey was made.

FHWA REGION	STATE	FED. AID PROJ NO.	SHEET NO.
8	ND.	F-1-094(006)915	

GENERAL NOTES

(SPALL REPAIR - PARTIAL DEPTH)
(Sta. 48+57 to 88-26)

550 SPALL REPAIR: Spall repair is defined as a repair that requires
380 removal of concrete to a three-inch depth or more but not full
depth. The minimum (1.5' x 1.5') area of a spall to be repaired
shall first be outlined by a saw cut. The cut shall be made a
minimum of three inches deep. Saw cuts beyond the area to be
patched will be kept to a minimum. Saw cuts made beyond the patch
area shall be sealed, with a non-shrinking mortar material, by the
contractor at his own expense.

All loose or unsound concrete within the area outlined by the saw
cut shall be removed with 15 pound chipping hammers (spade or
other wide flat bit) and hand tools, down to sound concrete for a
minimum depth of three inches.

Where the patch extends to the edge of the pavement, a form shall
be placed to match the patch edge to the pavement edge.

Prior to patching, the patch area shall be sandblasted. Then all
loose particles of concrete, dust, sand, and any other loose
material shall be removed from the spall area with air under
pressure. The contractor shall take care to prevent any of this
material from being directed toward the traffic lanes during
removal. Material removed from the spall shall not be piled on
the active traffic lanes.

When the spall area is thoroughly cleaned of all loose unsound
material, the resulting surface of the concrete in place shall be
painted with an even coat of the grout. The concrete for the
patch shall then be placed in the spall area before the grout
whitens. If any whitening occurs, the patch area shall be
sandblasted and regouted.

Grout used in the repair work shall consist of equal parts by
weight of Portland cement and fine aggregate mixed with water to
form a stiff slurry. The consistency shall be such that the
grout can be applied with a stiff brush to the old concrete in a
thin, even coating that does not run or puddle.

550 Portland Cement concrete, disposal of removed material, curing,
382 and damaged area replacement shall be the same as for full-depth
repair.

550 If, in the process of removing the existing pavement for spall
384 repair, it becomes apparent that damage to the pavement has
progressed to the point that a full depth repair is necessary as
directed by the engineer, the spall repair shall revert to
full-depth repair, subject to the approval of the engineer.
Payment for spall repair, which is changed to full-depth repair,
shall be one-half bid price for spall repair plus full bid price
for the full-depth repair. The one-half payment for spalled areas
which require full-depth repair shall be measured on the basis of
the originally-defined spall repair dimensions.

550 METHOD OF MEASUREMENT: Spall repair will be measured by the
386 square foot of the area of repair as specified and accepted by the
engineer.

550 BASIS OF PAYMENT: The quantities measured, as specified, will be
388 paid for at the contract unit price. This price will be
considered full compensation for all work performed and all
labor, materials, and costs incurred by this work.

550 TEMPERATURE CONTROL: The contractor shall not be allowed to pour
390 spall repair areas when air temperatures are below 40°F.

LONGITUDINAL P.C.C. JOINT CLEANING (NEW AND EXISTING): This work
shall be done in accordance with Section 550.04 M.

A hot-poured elastic-type joint filler which meets the
requirements of Section 826.02 A.2, shall be placed in all
centerline longitudinal joints on the project including repair
areas.

METHOD OF MEASUREMENT: "Transverse P.C.C. Joint Cleaning and
Sealing", "Random P.C.C. Crack Cleaning and Sealing", and
"Longitudinal P.C.C. Joint Cleaning and Sealing" shall be measured
by the linear foot of each joint cleaned (sawing included where
required), and sealed as specified by the Engineer.

BASIS OF PAYMENT: The quantities measured, as specified, will be
paid for at the contract unit price of each item. This price will
be considered full compensation for all work performed and all
labor, materials, and costs incurred by this work.

TRANSVERSE (EXISTING AND NEW JOINTS AT ENDS OF FULL DEPTH REPAIRS)
AND INTERMEDIATE TRANSVERSE JOINTS AND RANDOM CRACKS: Cleaning
and Sealing of Joints AND Cracks shall be in accordance with
Section 550.04 M.

RANDOM AND TRANSVERSE P.C.C. CRACK CLEANING AND SEALING: The
quantities provided may be adjusted by the engineer in the field.
Any adjustment in quantity shall not be a basis of renegotiation
in the unit price bid for "Random P.C.C. Crack Cleaning and
Sealing."

SUMMARY OF QUANTITIES

<u>SPEC</u>	<u>CODE</u>	<u>ITEM DESCRIPTION</u>	<u>UNIT</u>	<u>QUANTITY</u>
103	0100	Contract Bond	L. Sum.	1
202	0112	Removal of Concrete	Sq. Yd.	5,551
202	0114	Removal of Concrete Pavement	Sq. Yd.	27,541
202	0170	Removal of Culverts - All Types and Sizes	L. Ft.	86
202	0210	Removal of Manholes	Ea.	2
202	0235	Removal of Catch Basin	Ea.	11
203	0101	Common Excavation - Type A	Cu. Yd.	33,908
203	0107	Topsoil - Waste Area	Cu. Yd.	1,500
216	0100	Water	M. Gal.	950
302	0120	Aggregate Base Course Cl. 5	Ton	44,000
402	0110	Cold Bituminous Pavement	Ton	400
550	0112	8 In. Non-reinforced Concrete Pavement - Cl. AE	Sq. Yd.	22,494
550	0174	8 In. Non-reinforced Concrete Pavement - High Early Strength	Sq. Yd.	1,800
550	0230	Doweled Expansion Joint Assembly	L. Ft.	1,124
550	0240	Doweled Contraction Joint Assembly	L. Ft.	3,364
550	0420	Standard Anchorage Unit - J Bolts	Ea.	30
550	0424	Dowel Bars	Ea.	4,558
550	0650	Concrete Pavement Repair (Full Depth - Doweled)	Sq. Yd.	597
550	0660	Joint Repair (Full Depth - Doweled)	Sq. Ft.	12,566
550	0809	Preformed Compression Joint Seal 9/16 In.	L. Ft.	15,640
550	0958	Longitudinal Joint Silicone Seal	L. Ft.	3,757
550	0961	Expansion Joint Silicone Seal	L. Ft.	1,124
550	0963	Transverse P.C.C. Joint Cleaning and Sealing	L. Ft.	8,922

SUMMARY OF QUANTITIES

<u>SPEC</u>	<u>CODE</u>	<u>ITEM DESCRIPTION</u>	<u>UNIT</u>	<u>QUANTITY</u>				
550	0965	Longitudinal P.C.C. Joint Cleaning and Sealing	L. Ft.	17,392				
550	0966	Random P.C.C. Crack Cleaning and Sealing	L. Ft.	1,430				
550	1512	Spall Repair (Partial Depth)	Sq. Ft.	2,650				
702	0100	Mobilization	L. Sum	1				
704	0100	Flagging	M. Hr.	500	←	704 0105	Obliteration of Pavement Marking	L.Ft. 9425
706	0100	Field Laboratory - Type A	Ea.	1		704 1000	Traffic Control Signs	Unit 5692
708	2280	Seeding - Type B Class V	Acre	5		704 1051	Type II Barricades	Ea. 224
708	4000	Sodding	Sq. Yd.	260		704 1052	Type III Barricades	Ea. 36
714	0115	Pipe, Concrete Reinforced 12 In. - Cl. III - Sewer	L. Ft.	18		704 1060	Delineator Drums	Ea. 379
714	0210	Pipe, Concrete Reinforced 15 In. - Cl. III - Sewer	L. Ft.	724		704 1065	Traffic Cones	Ea. 308
714	0315	Pipe, Concrete Reinforced 18 In. - Cl. III - Sewer	L. Ft.	8		704 1087	Sequencing Arrow Panel - Type C	Ea. 2
714	0620	Pipe, Concrete Reinforced 24 In. - Cl. III - Sewer	L. Ft.	12				
714	1110	Pipe, Concrete Reinforced 48 In. - Cl. III - Sewer	L. Ft.	78				
722	0100	Manhole - 48 In.	Ea.	2				
722	0110	Manhole - 60 In.	Ea.	1				
722	1100	Manhole Riser - 48 In.	L. Ft.	6				
722	1110	Manhole Riser - 60 In.	L. Ft.	4				
722	3000	Manhole Casting	Ea.	4				
722	4100	Inlet	Ea.	10				
722	4110	Inlet, Double	Ea.	1				
722	4120	Inlet, Double Type S	Ea.	1				

SUMMARY OF QUANTITIES

<u>SPEC</u>	<u>CODE</u>	<u>ITEM DESCRIPTION</u>	<u>UNIT</u>	<u>QUANTITY</u>	
722	4300	Inlet, Special	Ea.	4	
722	4520	Inlet, Vaned Grates - Type II	Ea.	1	
722	4700	Inlet, Curb Casting	Ea.	6	
722	6200	Adjust Manhole	Ea.	27	
722	6240	Adjust Utility Appurtenance	Ea.	84	
748	0140	Curb and Gutter, Type I	L. Ft.	7,580	
750	0100	Sidewalk, Concrete	Sq. Yd.	6,639	
750	1010	Driveway, Concrete - High Early Strength	Sq. Yd.	831	
980	0200	Tree Grate	Ea.	16	
					752 0910 Safety Fence L. Ft. 1200
					762 0131 Temp. Stripe - Solid Line, Type R. - L.Ft.
					762 0132 Temp. Stripe - Solid Line, Type NR - L.Ft.

BASIS OF ESTIMATE

LIST OF STANDARDS

Description

Sheet
No.

Description

Aggregate Base Course - Class 5: 1.5 Ton/C.Y. + 25%

Water: 10 Gal./C.Y. of estimated embankment quantities and 20 Gal./Ton of aggregate base course. An estimated amount of water has been included in the quantities and shall be used as a dust palliative as directed by the engineer.

Topsoil: See Note 200-P05.

Seeding: See Note 200-P05.

Sodding: Areas where the existing grass is removed or disturbed by construction of this project shall be sodded. The exact locations and quantities shall be determined in the field.

MAXIMUM SIZE OF AGGREGATE

<u>Description</u>	<u>Type of Aggregate</u>	<u>Max. Size</u>
Aggregate Base Course Cl. 5	Crushed	3/4"

FHWA REGION	STATE	FED. AID PROJ. NO.	SHEET NO.
8	N.D.	F-1-094(006)915	

TYPICAL SECTIONS

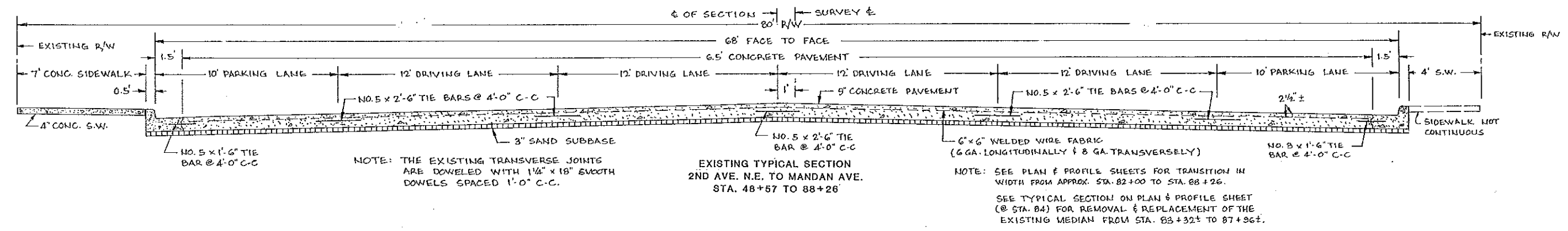
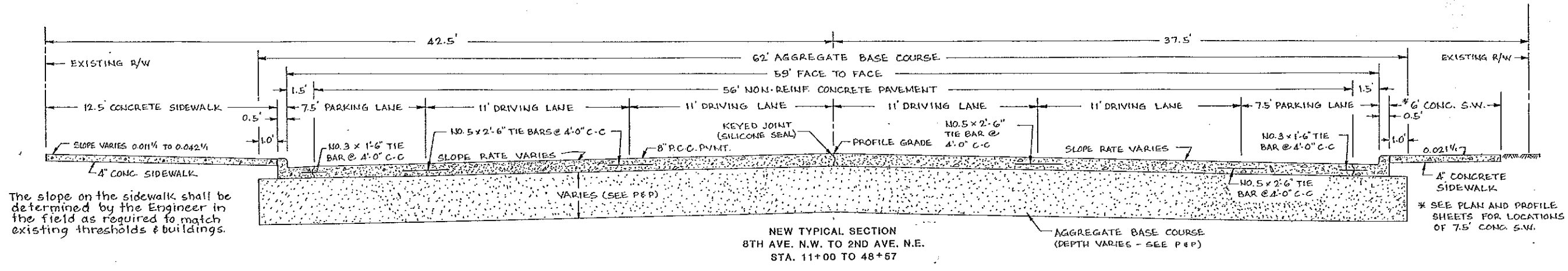

CURB AND GUTTER DETAILS

FHWA REGION	STATE	FED. AID PROJ. NO.	SHEET NO.
8	ND.	F-1-094 (006) 215	

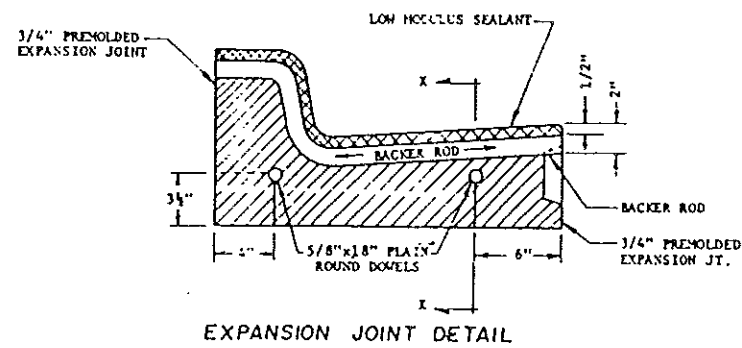

EXPANSION JOINT DETAIL

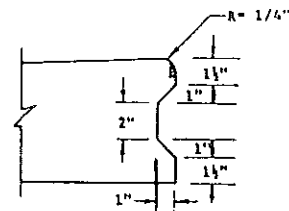

KEYWAY DETAIL FOR CURB & GUTTER

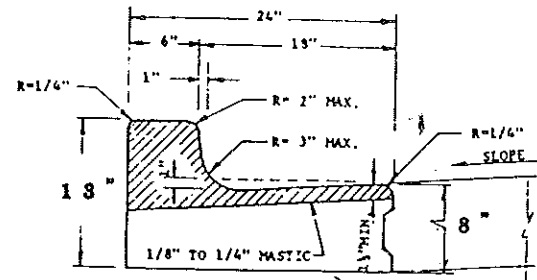

CURB & GUTTER TYPE I

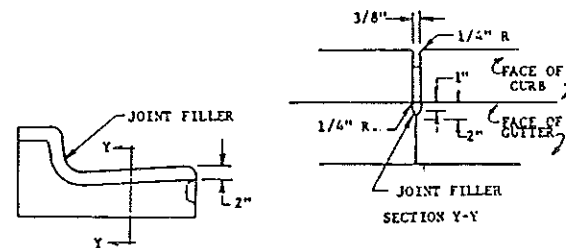

SCORED CONTRACTION JOINT DETAIL

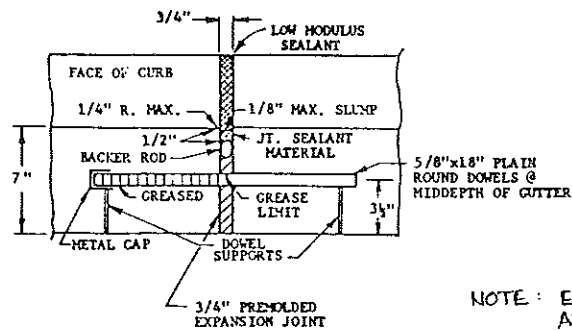

SECTION X-X

NOTE: EXPANSION JOINTS TO BE PLACED AT SAME LOCATION AS EXPANSION JOINTS IN THE P.C.C. PAVEMENT. (SEE PAVEMENT LAYOUT DETAILS)

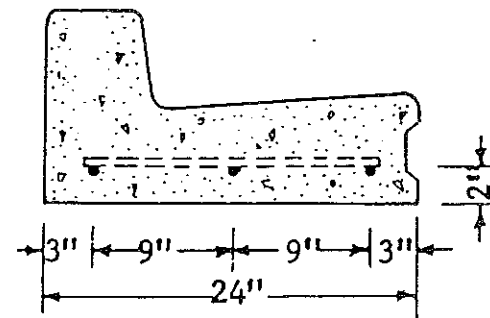

SECTION A-A

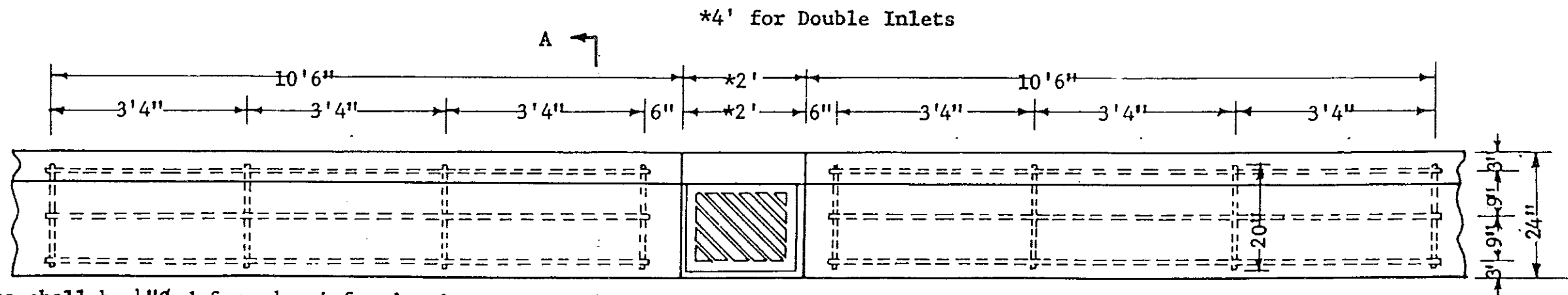

NOTE: All bars shall be 1/2 inch diameter deformed reinforcing bars. Splices will not be permitted. Reinforcing bars at inlet locations will not be paid for separately, but shall be included in the price bid for "Curb and Gutter - Type I".

CURB & GUTTER REINFORCING AT INLETS

FHWA REGION	STATE	FED. AID PROJ. NO.	SHEET NO.
8	N.D.	F-1-094(006)915	

CONCRETE DRIVEWAYS

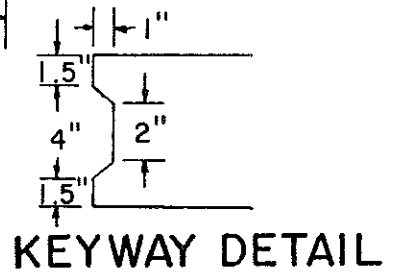
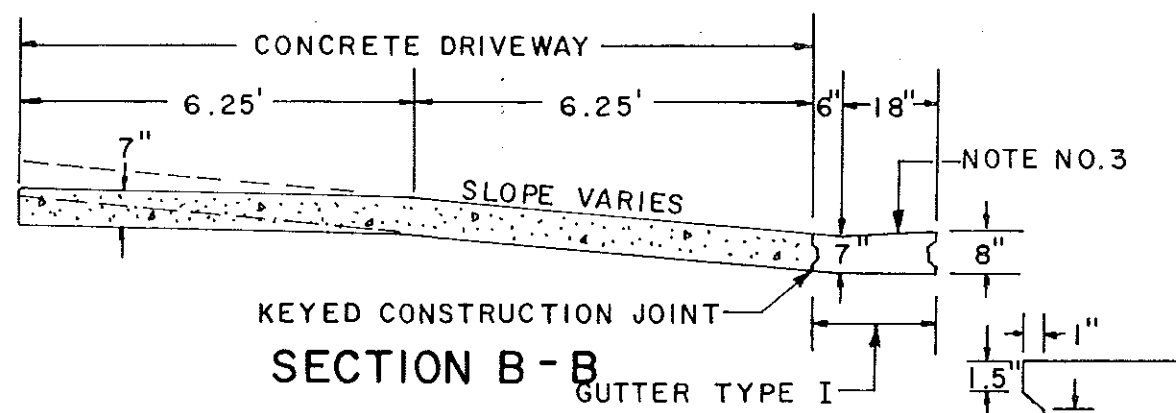
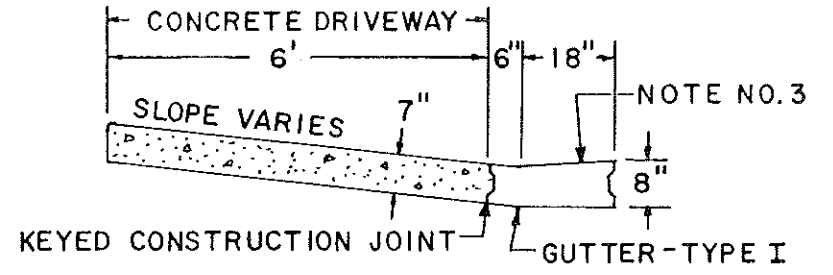
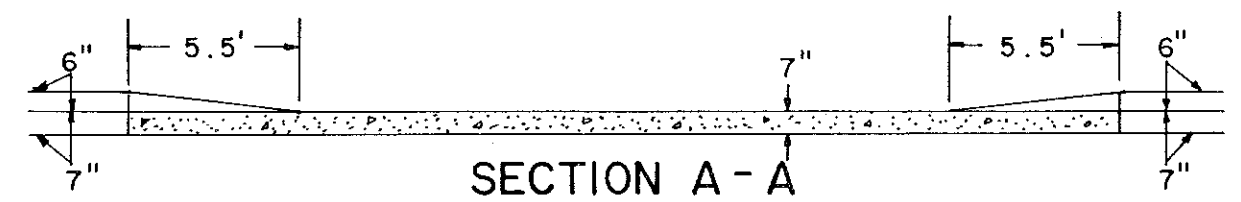
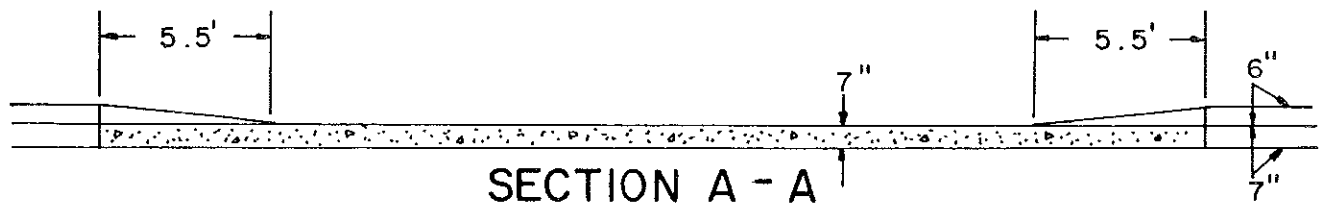
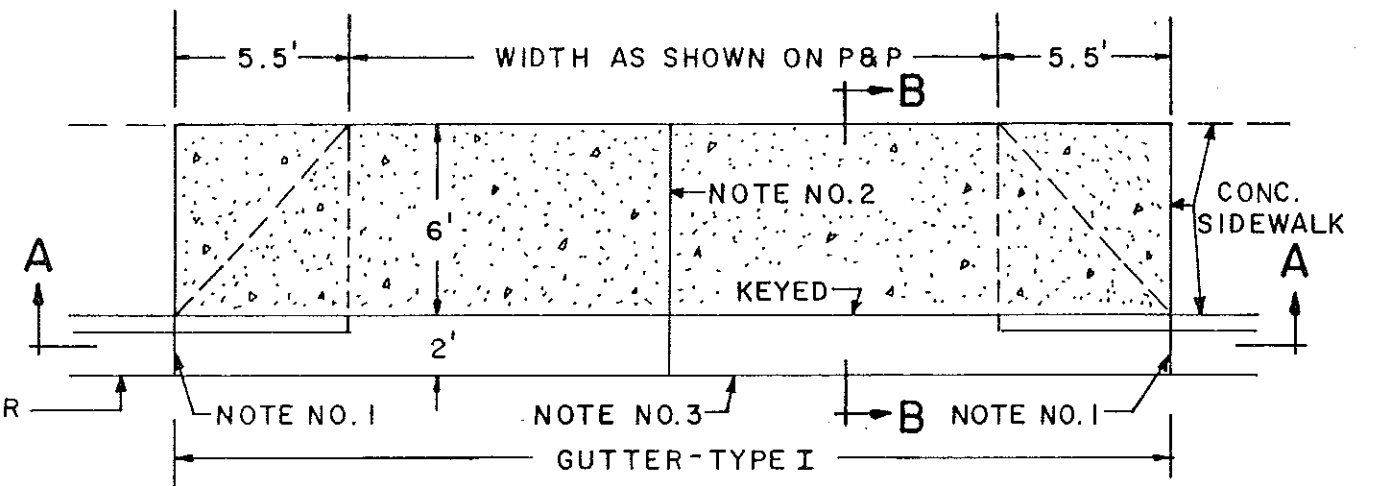
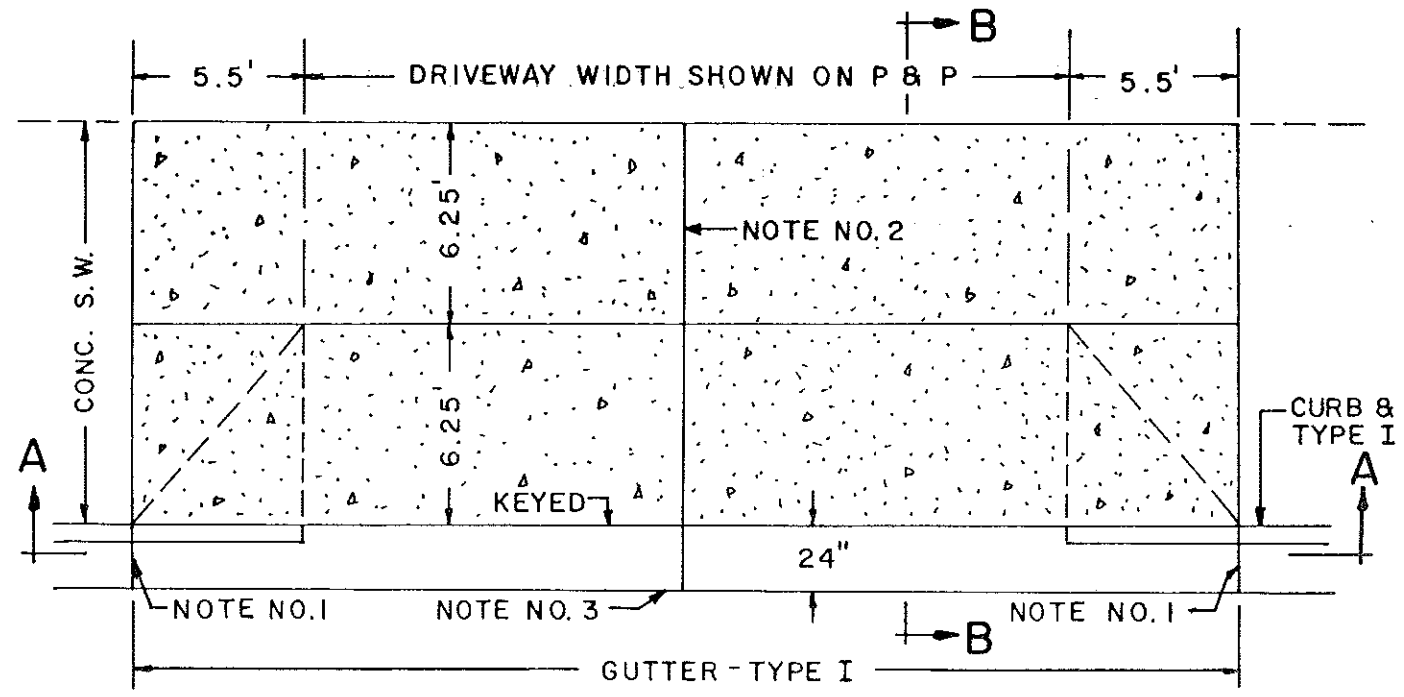

CONCRETE DRIVEWAYS
NORTH SIDE OF MAIN AVENUE

SECTION B-B
CONCRETE DRIVEWAYS
SOUTH SIDE OF MAIN AVENUE

- NOTE NO.1 3/4" PREMOLDED EXPANSION JOINT FULL DEPTH AND SAME SHAPE AS CURB AND GUTTER.
- NOTE NO.2 CENTER JOINT SHALL BE USED ON ALL DRIVEWAYS 16' IN WIDTH OR GREATER. JOINTS SHALL BE A KEYED CONSTRUCTION JOINT OR A CONTRACTION JOINT SCORED 1/3 THE DEPTH OF THE CONCRETE. JOINT SHALL BE SEALED IN A MANNER AND WITH A MATERIAL APPROVED BY THE ENGINEER.
- NOTE NO.3 GUTTER-TYPE I SHALL BE PAID FOR AT THE UNIT PRICE BID FOR "CURB AND GUTTER-TYPE I".

FEDERAL DISTRICT	STATE	PROJECT	SHEET NO.
8	N.D.	F-1-094(006)	

SIDEWALKS AND CURB RAMPS

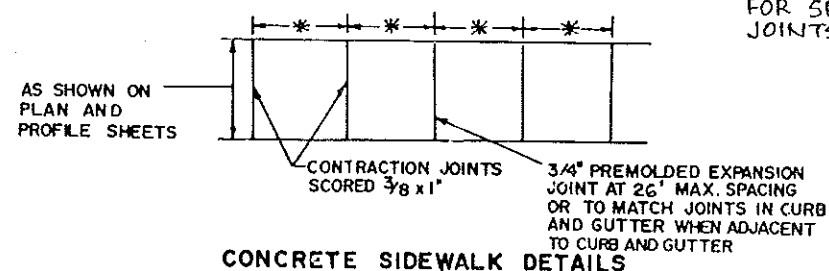
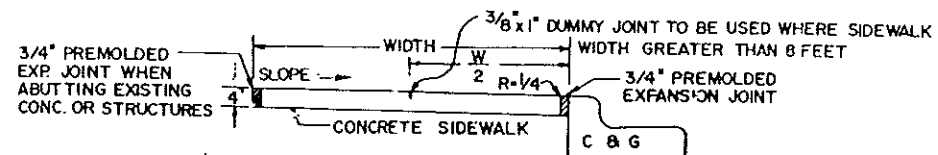

* SEE PAVEMENT LAYOUT DETAILS FOR SPACING OF CONTRACTION JOINTS

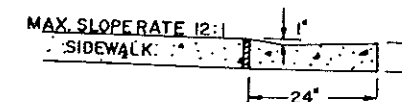
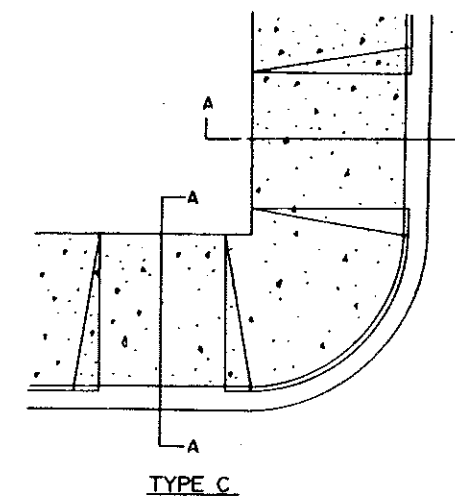
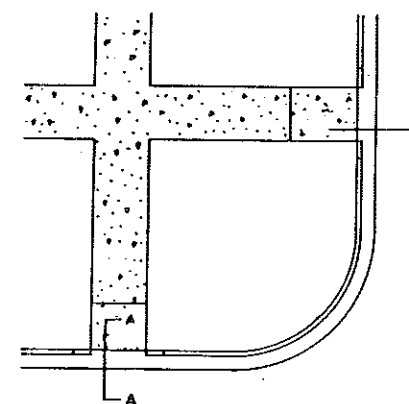

SEC. A-A



DEPRESSED CURB FOR PEDESTRIAN CROSSING

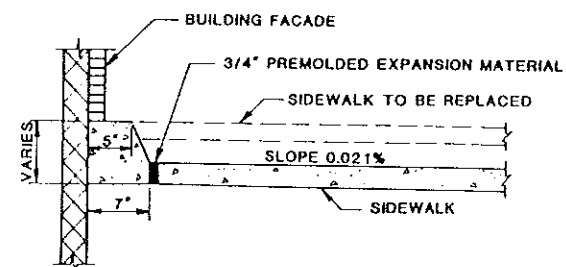
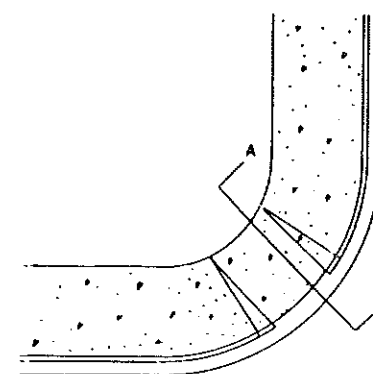

CURB DETAIL

NOTES:

1. METHOD OF PAYMENT THE CURB RAMP WILL NOT BE PAID FOR SEPARATELY BUT SHALL BE INCLUDED IN THE QUANTITIES AND PAID FOR AT THE UNIT PRICE BID FOR CONCRETE SIDEWALK AND CURB AND GUTTER.
2. THE TYPE OF CURB RAMP TO BE USED AT EACH INTERSECTION WILL BE INDICATED ON THE PLANS.
3. THE LOCATION AND TYPE OF RAMPS MAY BE CHANGED BY THE ENGINEER IN THE FIELD TO CONFORM TO EXISTING CONDITIONS.
4. AS SHOWN ON THE PLANS OR AT THE DIRECTION OF THE ENGINEER, A CURB SHALL BE CONSTRUCTED WHERE THE EXISTING SIDEWALK ABUTTING A BUILDING IS TO BE LOWERED. THE CURB SHALL BE CONSTRUCTED AS SHOWN IN THE CURB DETAIL. THE COST FOR THE CURB SHALL BE THE PRICE BID FOR CONCRETE SIDEWALK.
5. THE SLOPE ON THE SIDEWALK WILL VARY FROM 0.011% TO 0.042%. THE ENGINEER IN THE FIELD SHALL ADJUST THE SLOPE AS REQUIRED TO MATCH EXISTING BUILDINGS, DOORWAYS, ETC. A SLOPE OF 0.021% SHALL BE USED WHERE POSSIBLE.

FHWA REGION	STATE	FED. AID PROJ. NO.	SHEET NO.
8	N.D.	F-1-094(006)915	

SPECIAL INLET STA. 35+74 RT.

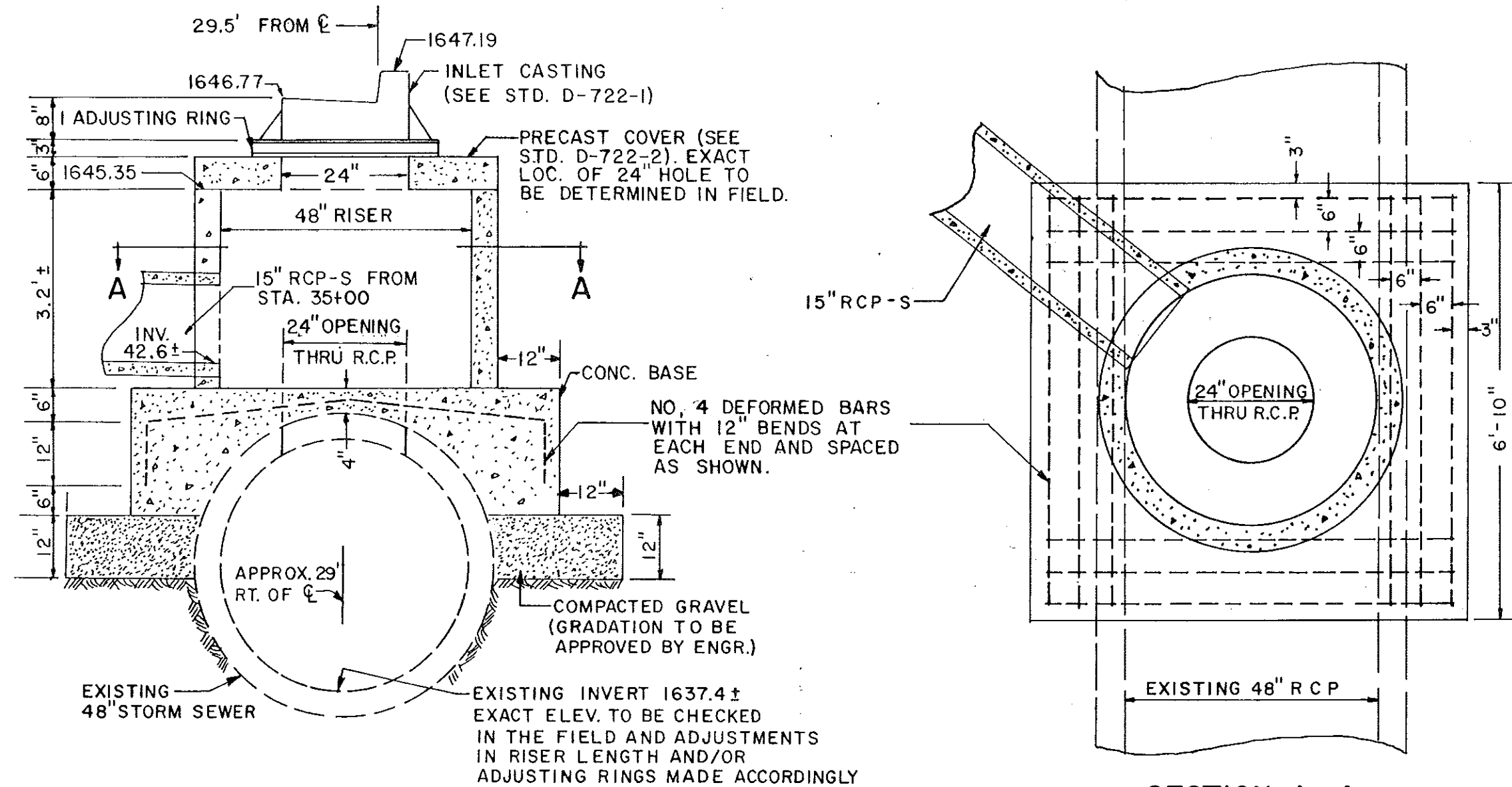

FHWA REGION	STATE	FED. AID PROJ. NO.	SHEET NO.
8	N.D.	F-1-094(006) 915	

SPECIAL INLET STA. 41+25-29' LT.

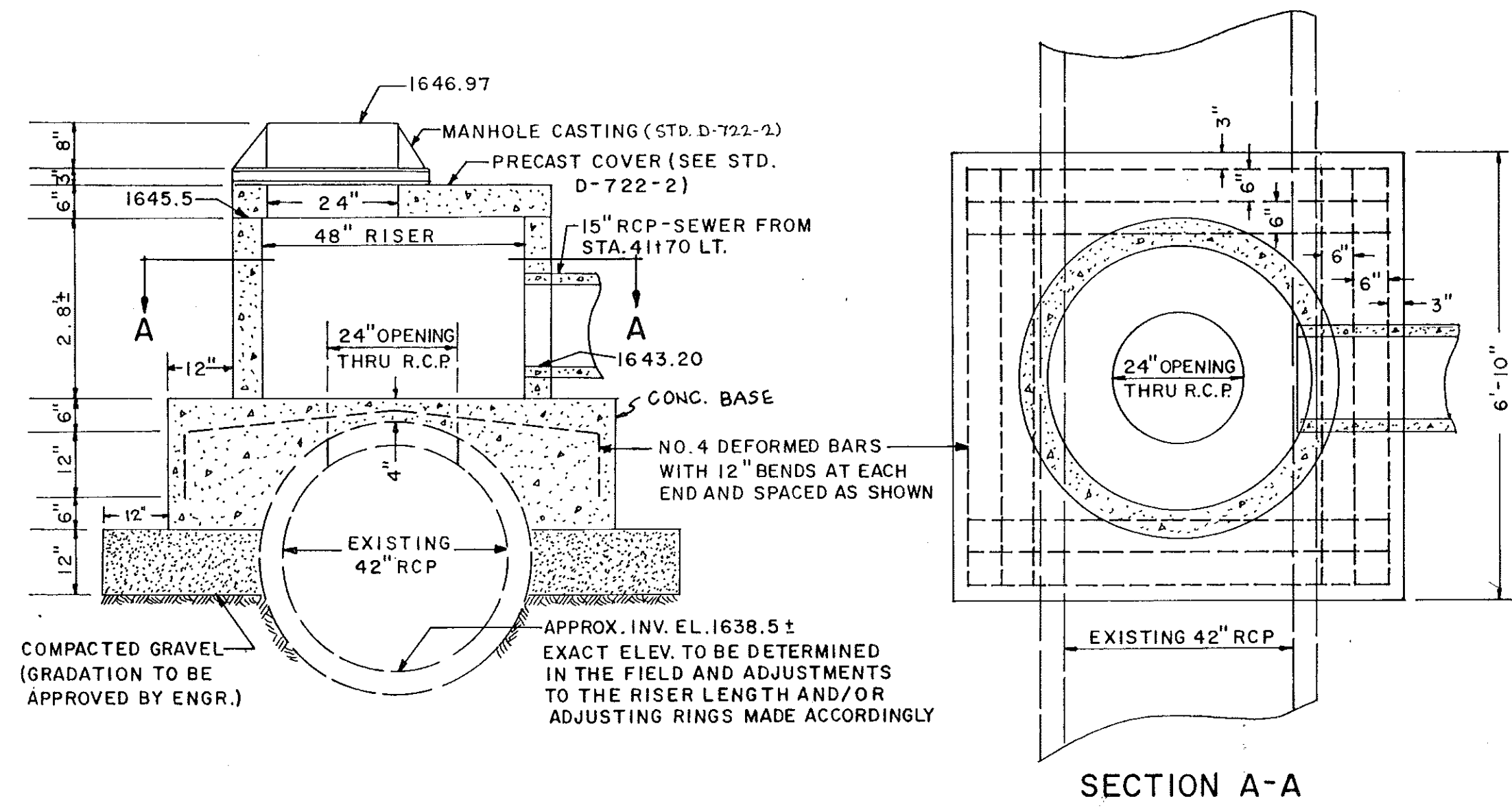

SPECIAL INLET
STA. 44+22 RT.

FHWA REGION	STATE	FED. AID PROJ. NO.	SHEET NO.
8	N.D.	F-1-094(006)915	

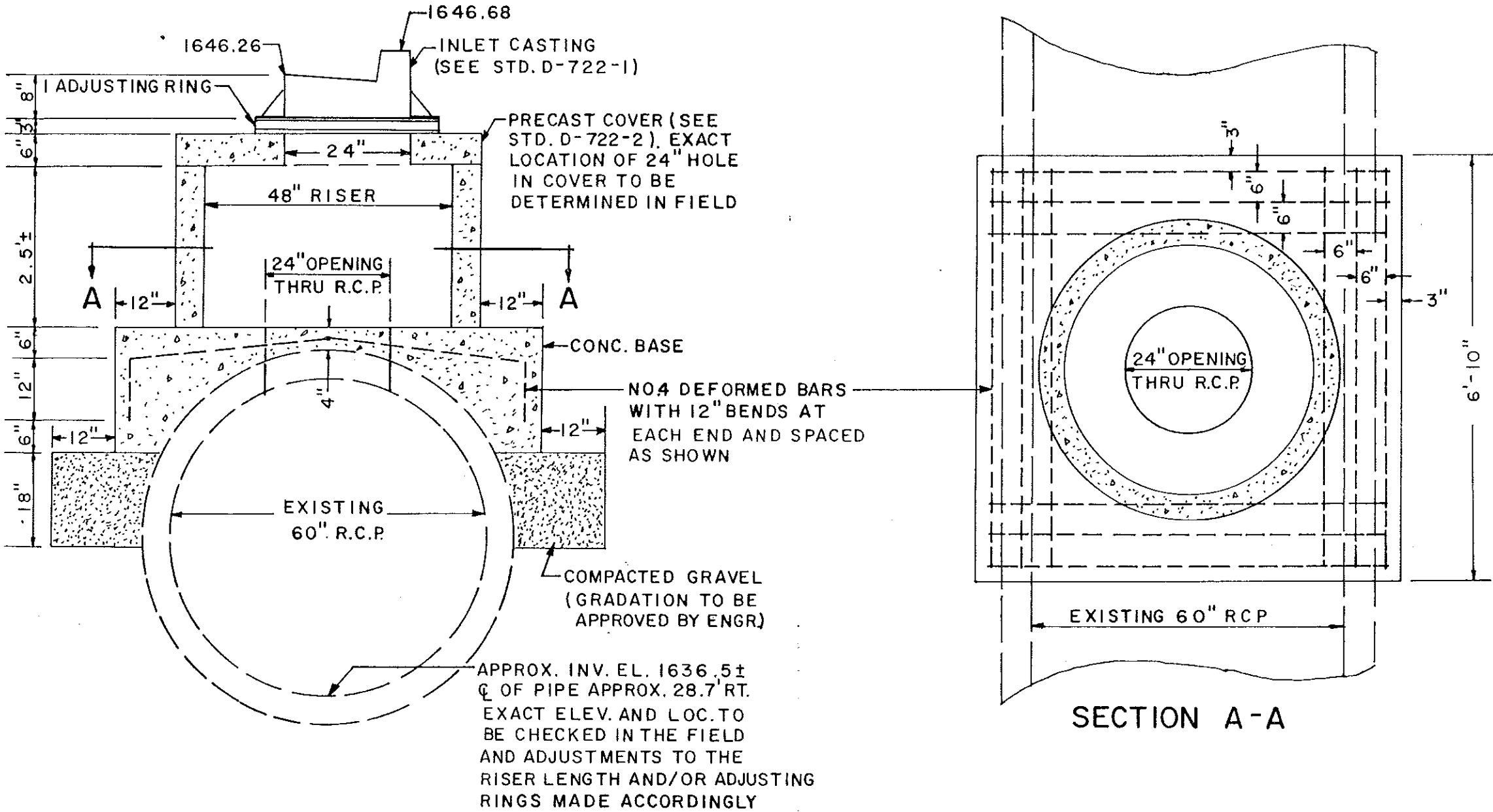

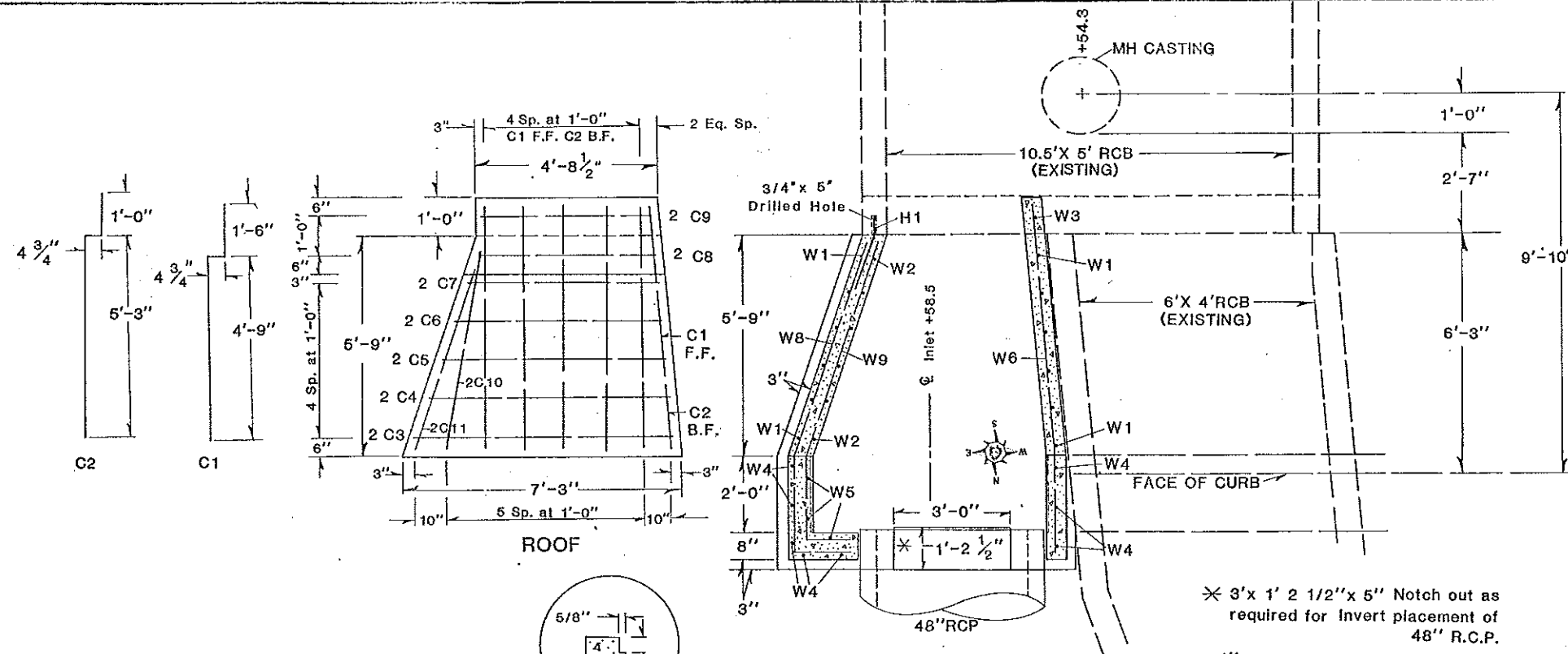

F.F.: FRONT FACE
B.F.: BACK FACE

CONSTRUCTION NOTES:
REINFORCEMENT:
 The Contractor's attention is directed to paragraph 612.03A of the North Dakota Standard Specifications regarding the verification of the reinforcing steel quantity, size, & shape.
 The Transverse & Vertical Bars shall be placed nearest the surface. The Longitudinal, Temperature or Tie Bars shall be placed, immediately inside the Vertical & Transverse Bars & the intersections wired.
 The clear distance from the nearest bar to the surface of the concrete shall be as follows:
 Bottom of Floor Slab 2-1/2" Clear
 Top of Floor Slab 2" Clear
 East Wall 2" Clear
 Top of Roof Slab 2" Clear
 Bottom of Roof Slab 1" Clear
 Dimensions of bent bars are given out to out. All bends conform to A.C.I. standards unless indicated otherwise.

BAR LIST				
MARK	SIZE	LENGTH	SHAPE	NO.
W1	4	6'-1"	BENT	12
W2	4	4'-0"	STR.	6
W3	4	4'-5"	STR.	1
W4	4	6'-9"	BENT	8
W5	4	4'-8 1/2"	STR.	3
W6	4	9'-0"	BENT	5
W7	4	2'-2"	STR.	1
W8	4	9'-8"	BENT	3
W9	4	8'-10"	BENT	3
W10	4	3'-10 1/2"	BENT	1
W11	4	3'-0 1/2"	BENT	1
B1	4	8'-2"	STR.	9
B2	4	6'-2"	STR.	2
B3	4	8'-2"	BENT	2
B4	4	7'-0"	STR.	3
B5	4	7'-2"	STR.	5
B6	4	2'-6"	STR.	1
B7	4	1'-4"	STR.	1
B8	4	6'-9"	STR.	2
B9	4	6'-6"	STR.	2
B10	4	6'-1"	STR.	2
B11	4	5'-8"	STR.	2
B12	4	5'-3"	STR.	2
B13	4	4'-9"	STR.	2
C1	4	6'-7 3/4"	BENT	6
C2	4	6'-7 3/4"	BENT	6
C3	4	6'-6"	STR.	2
C4	4	6'-2"	STR.	2
C5	4	5'-8"	STR.	2
C6	4	5'-3"	STR.	2
C7	4	4'-9"	STR.	2
C8	4	4'-6"	STR.	2
C9	4	4'-5"	STR.	2
C10	4	5'-0"	STR.	2
C11	4	4'-9"	STR.	2
H1	4	1' 11"	BENT	4

The Contract Unit price for "Inlet Double Type S" will be full compensation for all tools, labor, equipment & material necessary to construct & dampproof the inlet detail on this sheet. This price shall also include furnishing & installing a Type II Double Inlet (Vaned Grate) Casting.

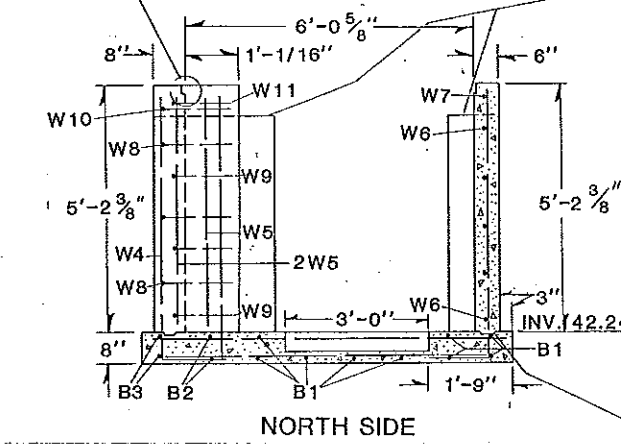
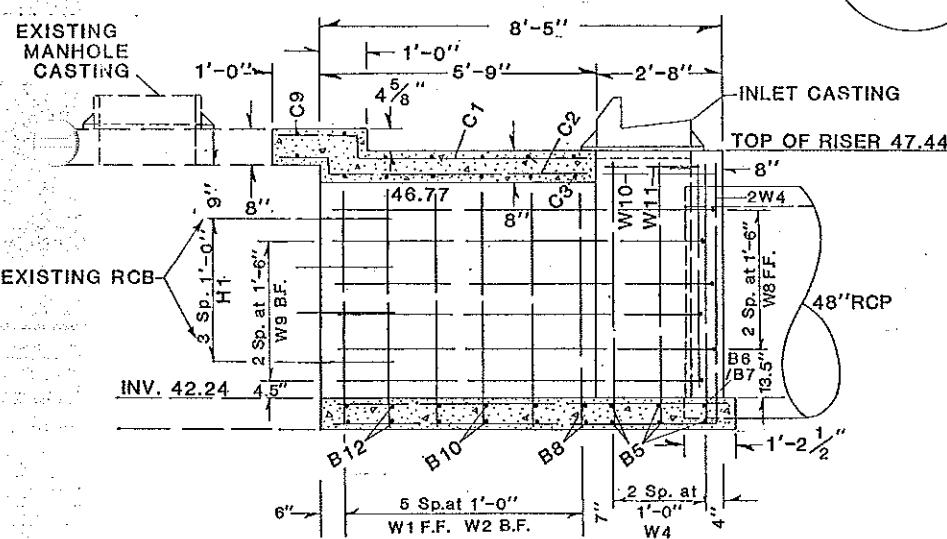

* 3' x 1' 2 1/2" x 5" Notch out as required for Invert placement of 48" R.C.P.

All Keys Shown Are 1-1/2" x 3-1/2"

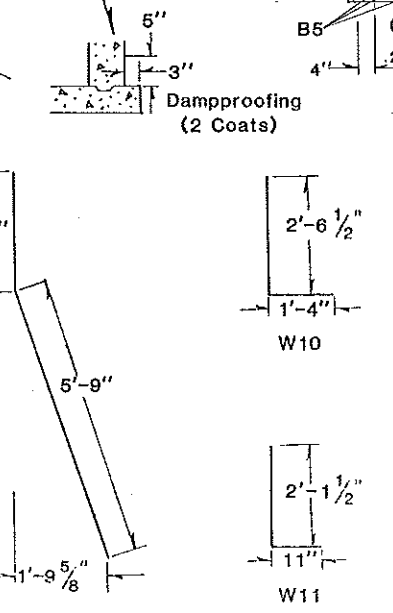
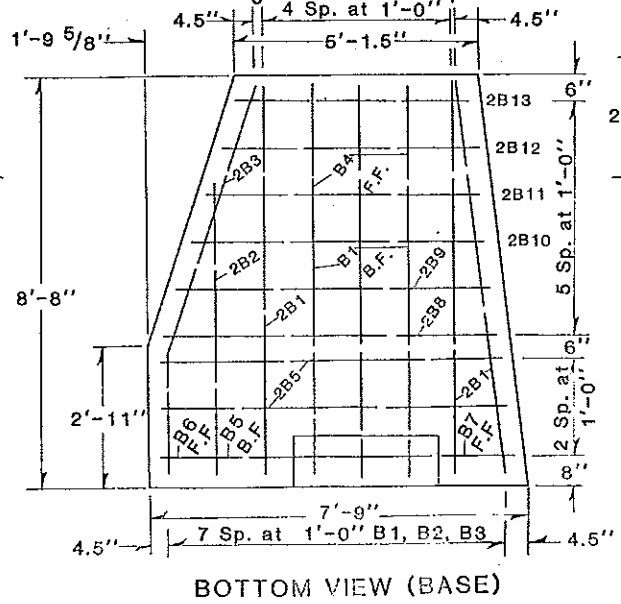
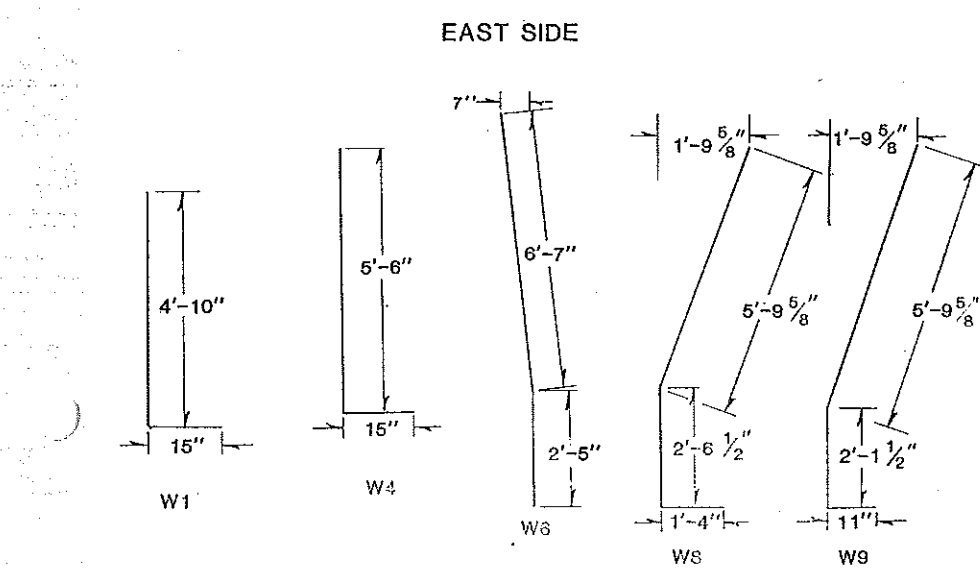
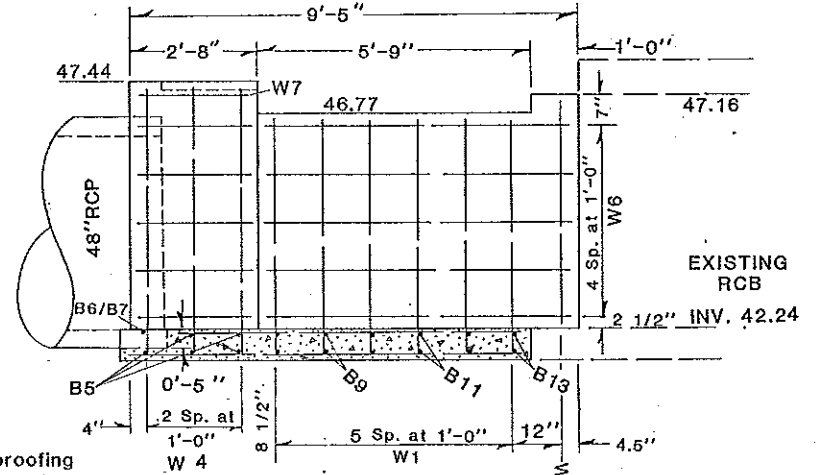

H1 bars shall be installed with an epoxy resin adhesive meeting AASHTO M 235.

A Type II Double Inlet Casting with Vaned Grate shall be used at this location.

CONCRETE:
 All concrete shall be Class AE-3 & shall be compacted by vibration.
 The following elements of each section shall be poured in one continuous run.

1. Floor Slab
2. Each Sidewall
3. Roof Slab

All exposed edges of concrete shall be beveled with 3/4" triangular molding. The concrete in the walls shall be allowed to set at least 2 (two) hours before the roof slab is poured.

LOAD FACTOR DESIGN:
 FC - 3,000 PSI FY - 60,000 PSI

FED. AID REGION	STATE	FED. AID PROJ. NO.	SHEET NO.
8	N.D.	F-1-094(006)915	

MANHOLE BLOCKOUT DETAIL SHEET

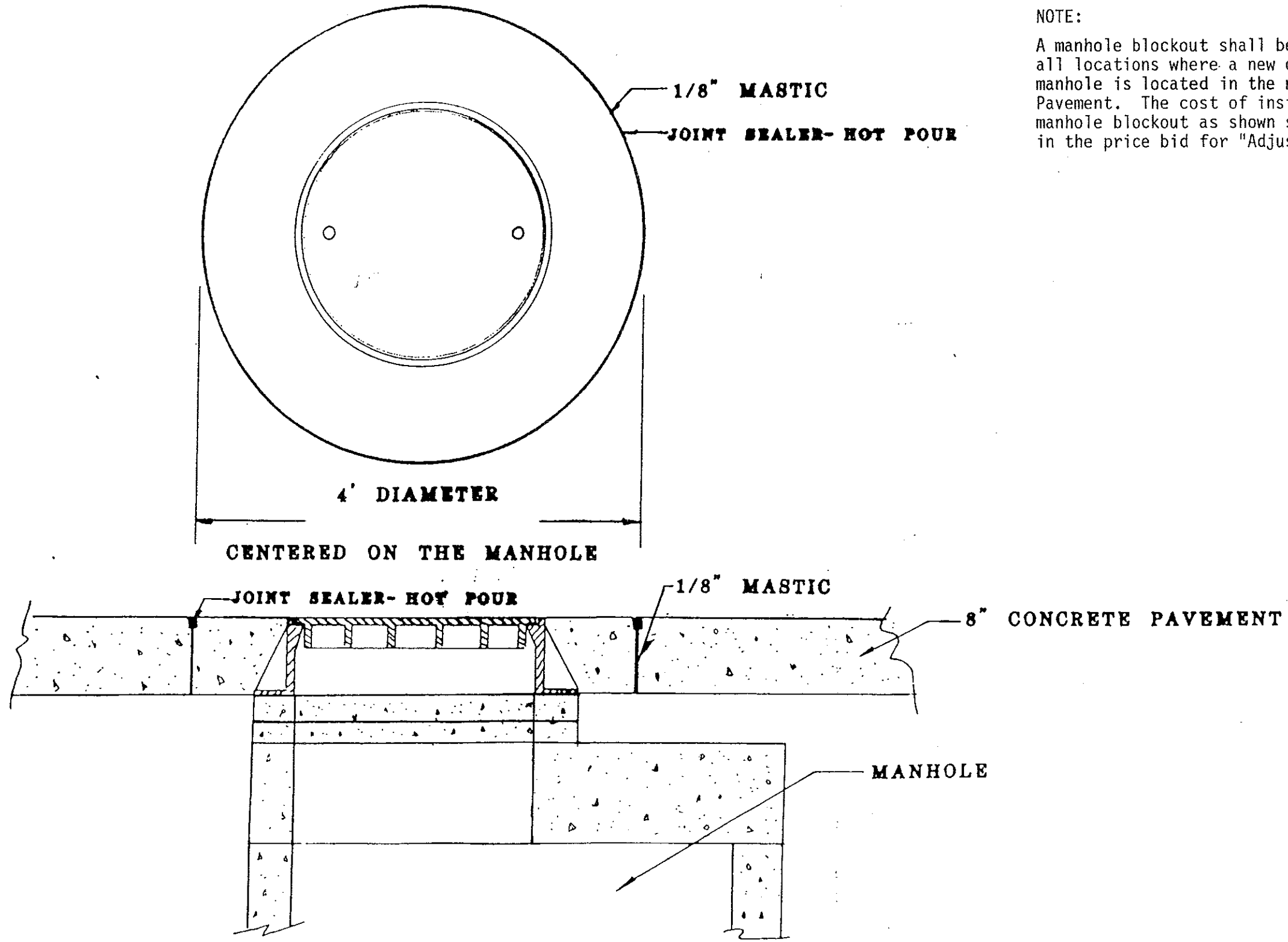

NOTE:
 A manhole blockout shall be installed at all locations where a new or existing manhole is located in the new P.C.C. Pavement. The cost of installing the manhole blockout as shown shall be included in the price bid for "Adjust Manholes."

TREE GRATE

FHWA REGION	STATE	FED. AID PROJ. NO.	SHEET NO.
8	N.D.	F-1-094(006)915	

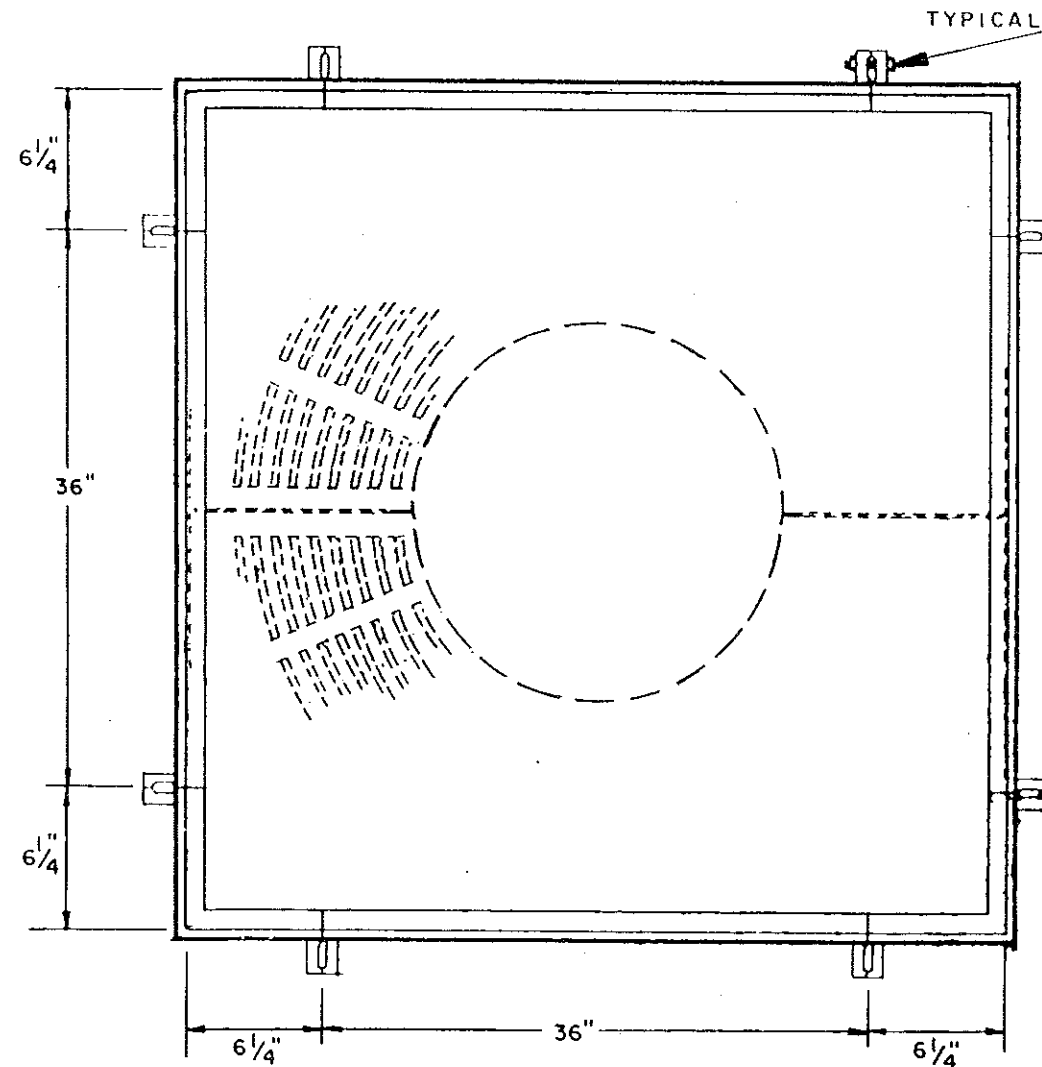

FRAME

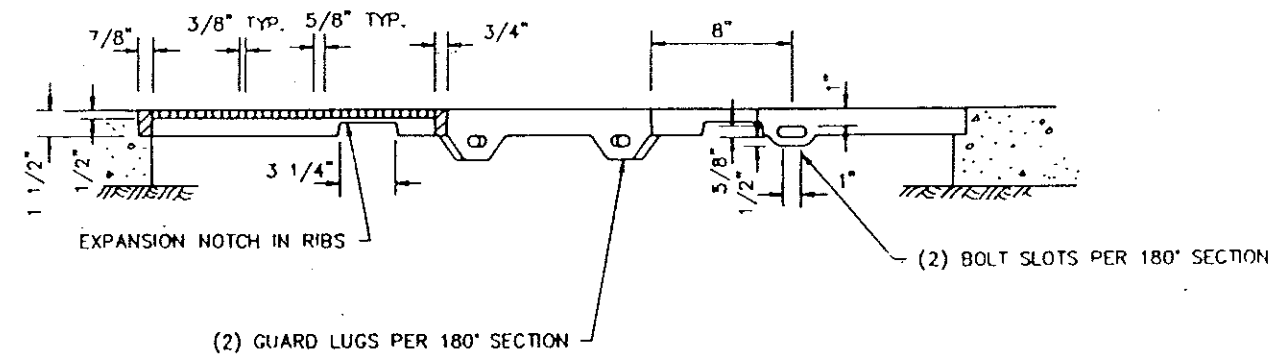
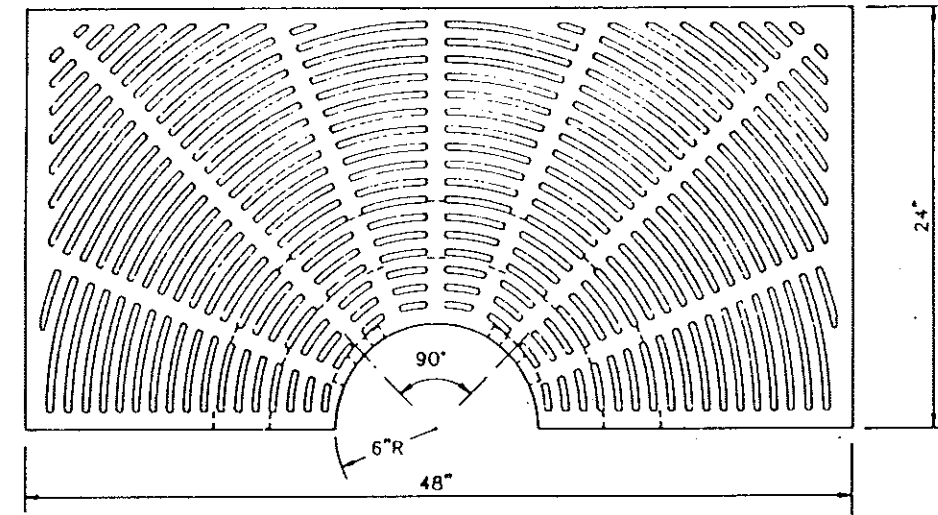

TREE GRATE
(APPROX. WEIGHT 270 LBS.)

Notes:

Material for the frames and grates shall be gray iron ASTM A-48, Class 35B (not painted).

The frames shall be bolted together and cast into the concrete sidewalk. This must be level and the seat for the grate must be in a true flat plane to prevent rocking of the grate.

The price bid for "Tree Grate" will be full compensation for all labor, equipment, and materials necessary to complete the work as specified.

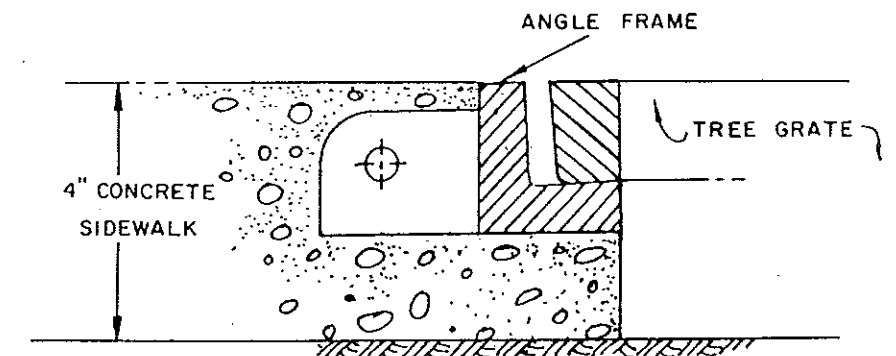
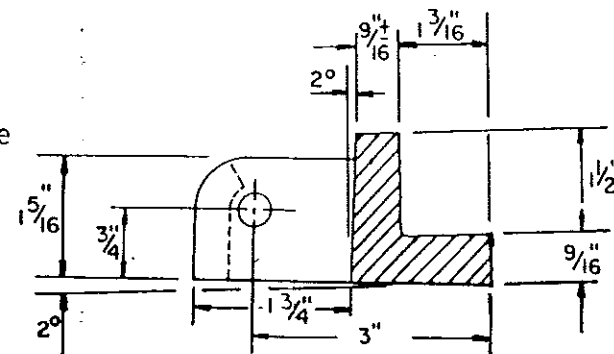

FHWA REGION	STATE	FED. AID PROJ. NO.	SHEET NO.
8	N. D.	F-1-094(006) 915	

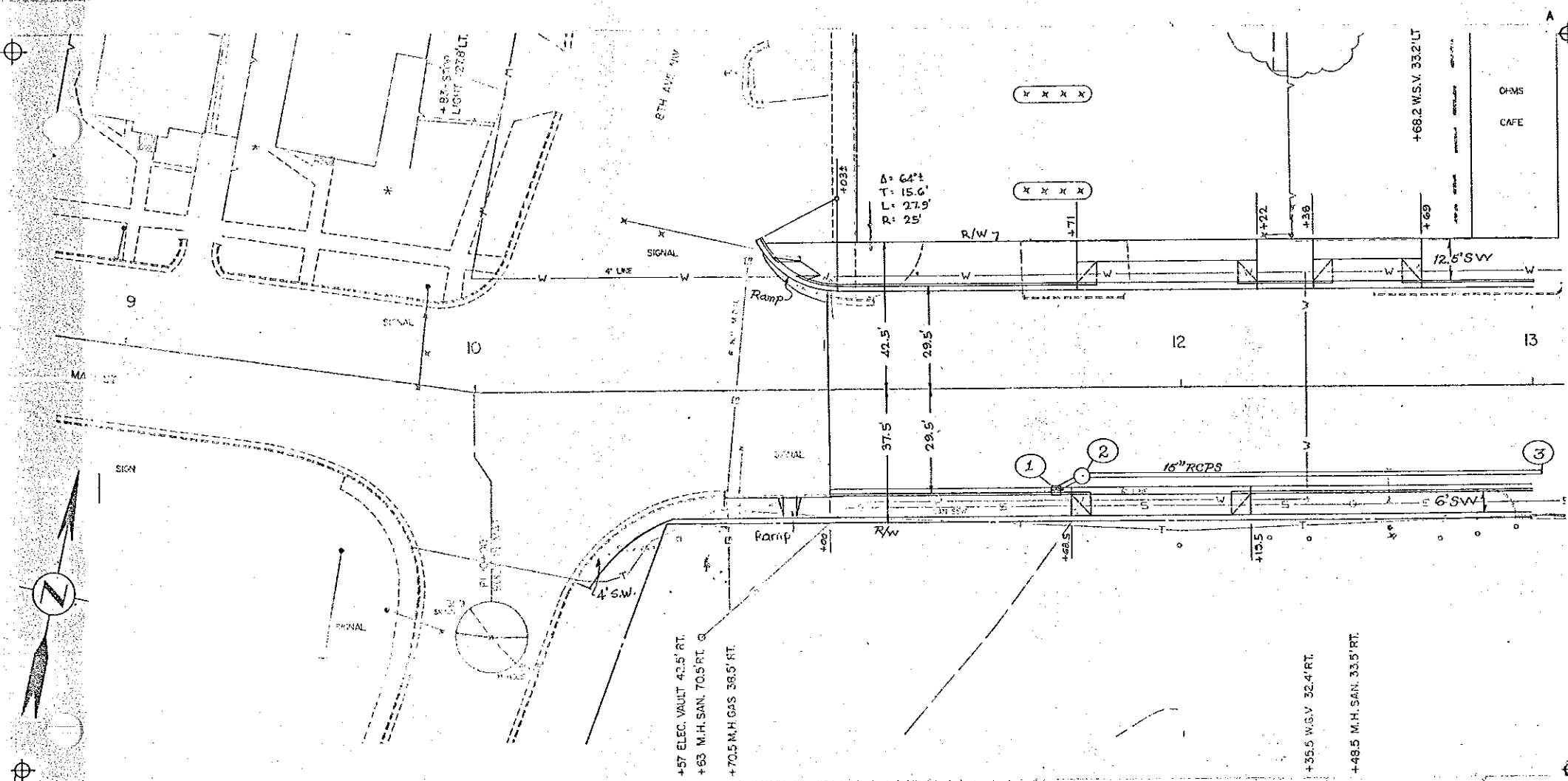

CURB & GUTTER-TYPE I

10+81 to 13+00 Lt. 224.9 L.F.
 11+00 to 13+00 Rt. 200.0 L.F.

DRIVEWAY, CONCRETE (H.E.S.)

11+94.0 Rt. 40' 34.0 S.Y.
 11+96.5 Lt. 40' 70.8 S.Y.
 12+53.5 Lt. 20' 43.1 S.Y.

SIDEWALK, CONCRETE

10+81 to 13+00 Lt. 177.6 S.Y.
 10+29 To 13+00 Rt. -142.4 S.Y.

REMOVAL OF CONCRETE PAVEMENT

11+00 to 13+00 1491 S.Y.

REMOVAL OF CONCRETE

11+00 to 13+00 202 S.Y.

ADJUST UTILITY APPURTENANCE

12+35.5 Rt. 32.4' 1 W.G.V.
 12+68.2 Lt. 33.2' 1 W.G.V.

ADJUST MANHOLE

12+48.5 Rt. 33.5' 1 Ea.

INLET, VANED GRATE, TYPE II

① 1 Ea.

MANHOLE 48"

② 1 Ea.

MANHOLE RISER

② 48"x2.7 L.F.

PIPE, CONC. REINF. CL.III SEWER

① to ② 15"x6 L.F.
 ② to ③ 15"x 126 L.F.

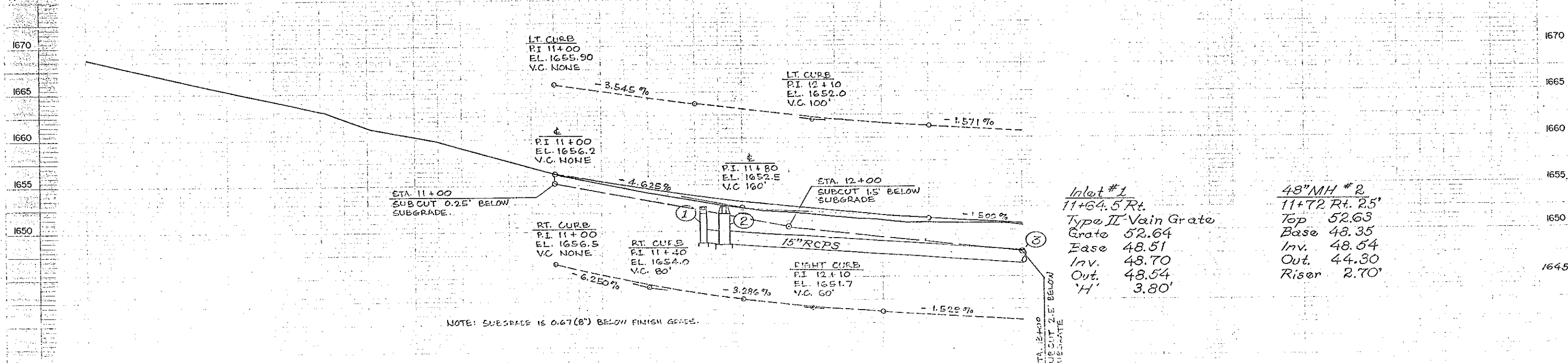

Inlet #1
 11+64.5 Rt.
 Type II Vain Grate
 Grate 52.64
 Ease 48.51
 Inv. 48.70
 Out. 48.54
 'H' 3.80'

48" MH #2
 11+72 Rt. 2.5'
 Top 52.63
 Base 48.35
 Inv. 48.54
 Out. 44.30
 Riser 2.70'

NOTE: SUBGRADE IS 0.67(8") BELOW FINISH GRADE.

BENCH MARKS			
NO.	LOCATION	DESCRIPTION	ELEV.
1		S.W. COR. CONCRETE FOR CONDO SIGN	1656.65

FHWA REGION	STATE	FED. AID PROJ. NO.	SHEET NO.
8	N.D.	F-1-094(006) 915	

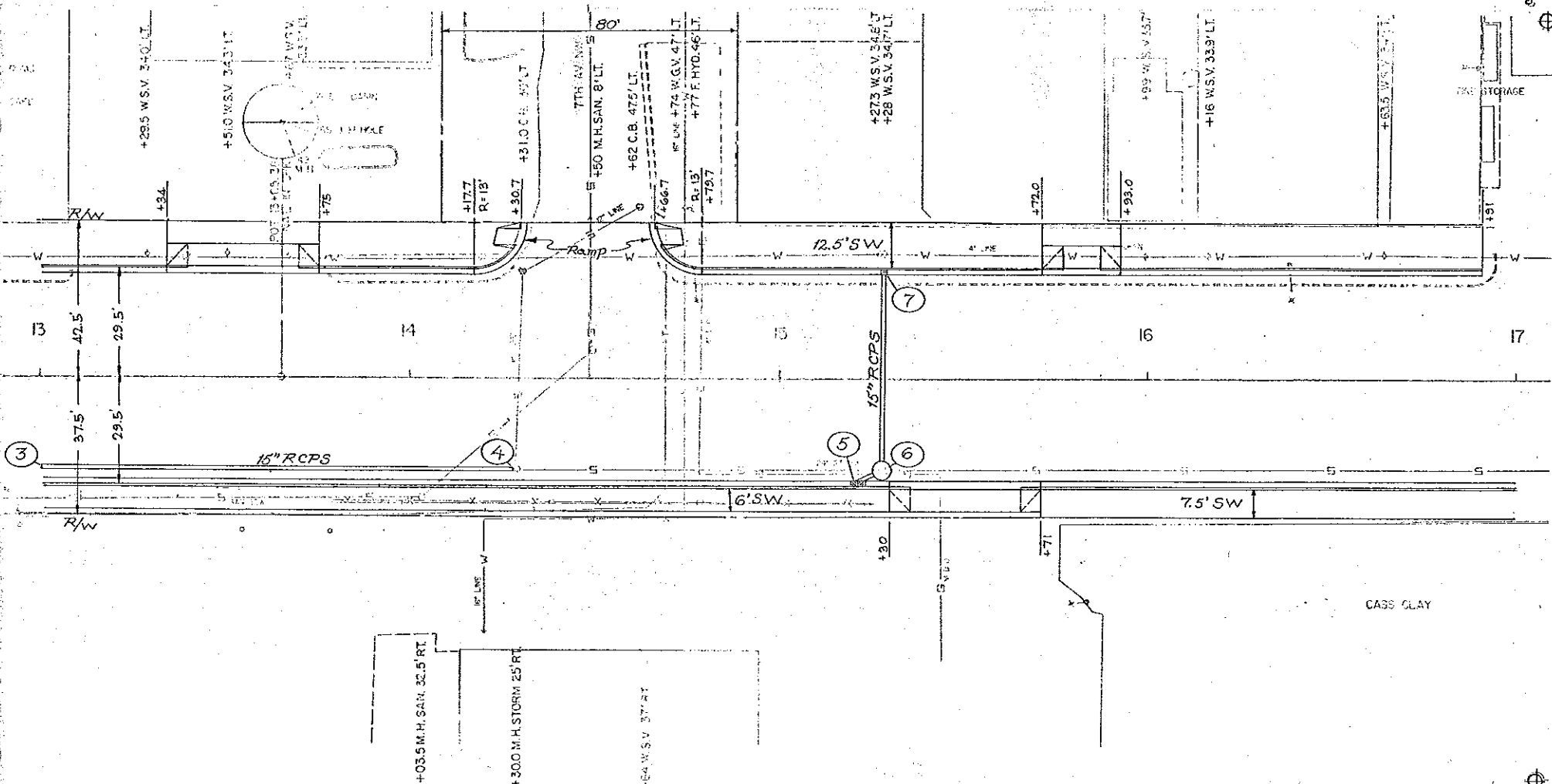

CURB & GUTTER-TYPE I

13+00.0 to 14+30.7 Lt. 138.1 L.F.
 13+86.7 to 16+91.0 Lt. 240.7 L.F.
 13+00.0 to 17+00.0 Rt. 400.0 L.F.

DRIVEWAY, CONCRETE (H.E.S.)

13+54.5 Lt. 30' 56.9 S.Y.
 15+82.5 Lt. 10' 29.2 S.Y.
 15+50.5 Rt. 30' 27.3 S.Y.

SIDEWALK, CONCRETE

13+00 to 16+91 Lt. 398.1 S.Y.
 13+00 to 17+00 Rt. 260.8 S.Y.

REMOVAL OF CONCRETE PAVEMENT

13+00 to 17+00 2975 S.Y.

REMOVAL OF CONCRETE

13+00 to 17+00 453 S.Y.

ADJUST UTILITY APPURTENANCE

13+29.5 Lt. 34.0' W.S.V. 1 Ea.
 13+51.0 Lt. 34.3' W.S.V. 1 Ea.
 13+67.0 Lt. 33.3' W.G.V. 1 Ea.
 14+64.0 Rt. 37.0' W.S.V. 1 Ea.
 15+27.3 Lt. 34.8' W.S.V. 1 Ea.
 15+28.0 Lt. 34.7' W.S.V. 1 Ea.
 15+99.0 Lt. 33.7' W.S.V. 1 Ea.
 16+16.0 Lt. 33.9' W.S.V. 1 Ea.
 16+63.5 Lt. 34.0' W.S.V. 1 Ea.

ADJUST MANHOLE

14+03.5 Rt. 32.5' 1 Ea.
 14+50.0 Lt. 8.0' 1 Ea.

INLET

7 1 Ea.

INLET, DOUBLE

5 1 Ea.

MANHOLE CASTING

14+30 Rt. 25' 1 Ea.
 14+31 Lt. 30' 1 Ea.

MANHOLE-60"

6 1 Ea.

MANHOLE RISER

6 60"x3.8 L.F.

PIPE, CONC. REINF. CL. III SEWER

3 to 4 15"x128 L.F.
 6 to 6 15"x 6 L.F.
 6 to 7 15"x 52 L.F.

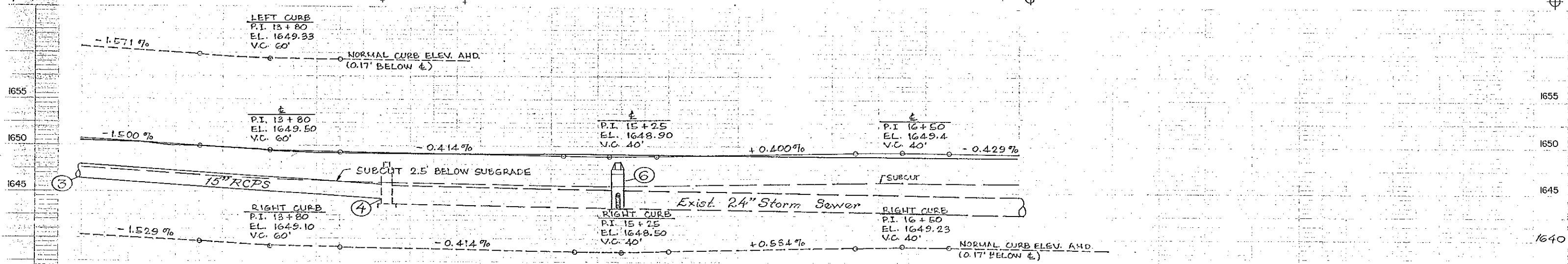

60" MH #6
 15+28.4 Rt. 25'
 Top 48.22
 Base 42.67
 Inv. 43.25±(Exist. 24")
 Out. Existing
 Riser 3.80'

Inlet # & Type	#5-DBL	#7-Inlet
Sta.	15+21.6 Rt.	15+25 Lt.
Grate	48.05	48.26
Base	44.09	44.98
Inv.	44.28	45.17
Out.	44.08	44.20
H'	3.50'	2.70'

BENCH MARK			
NO.	LOCATION	DESCRIPTION	ELEV.
2	14+77 - 46' LT.	TOP OF HYDRANT	1650.77

FHWY REGION	STATE	FED. AID PROJ. NO.	SHEET NO.
8	N. D.	F-1-094(006)915	

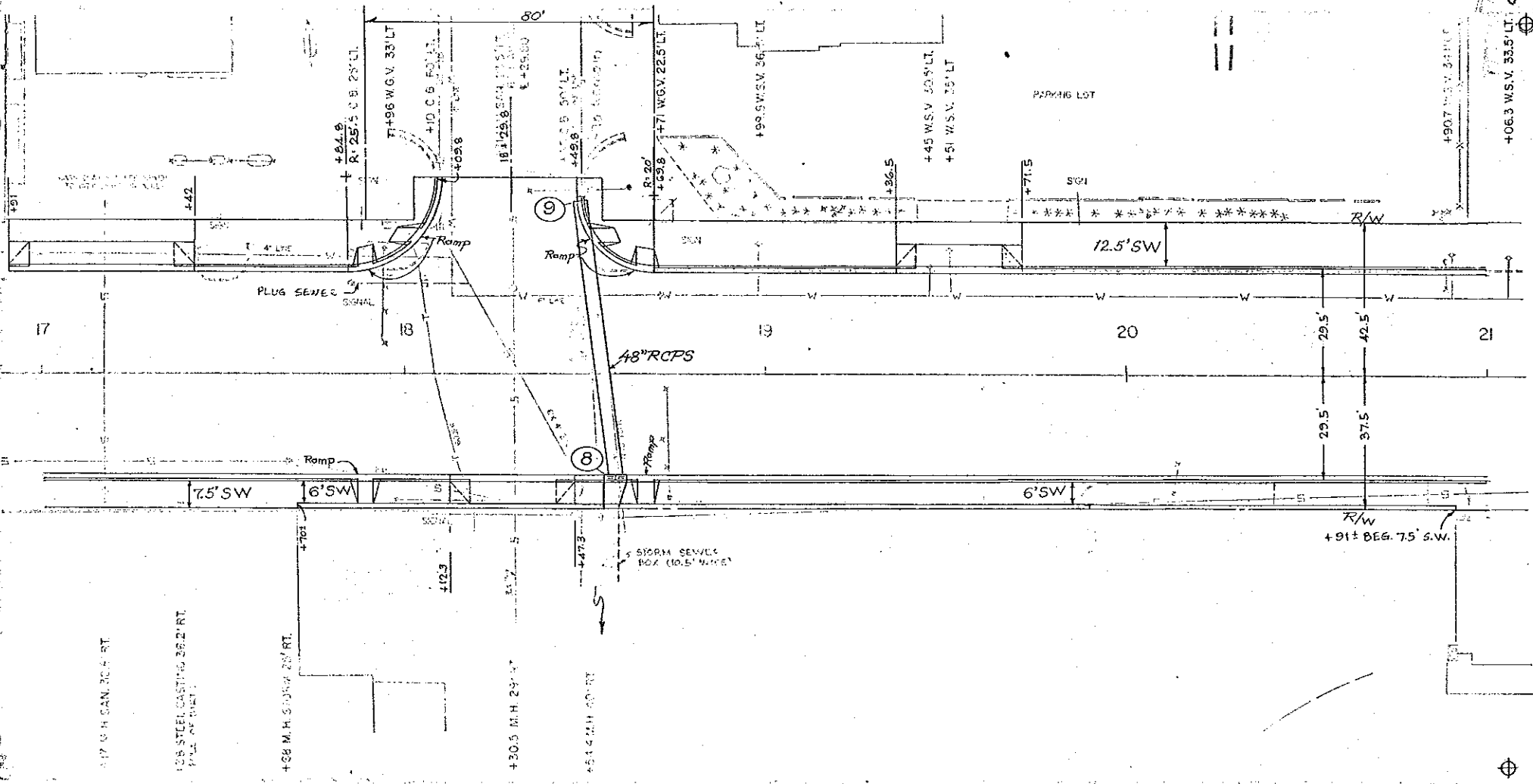

CURB & GUTTER TYPE I

16+91.0 to 18+09.8 Lt. 82.1 L.F.
 18+49.8 to 21+00.0 Lt. 261.6 L.F.
 17+00.0 to 21+00.0 Rt. 400.0 L.F.

DRIVEWAY, CONCRETE (H.E.S.)

17+16.5 Lt. 40' 70.8 S.Y.
 18+29.8 Rt. 24' 23.3 S.Y.
 19+54.0 Lt. 24' 48.6 S.Y.

SIDEWALK, CONCRETE

17+42 to 21+00 Lt. 393.1 S.Y.
 17+00 to 21+00 Rt. 266.5 S.Y.

REMOVAL OF CONCRETE PAVEMENT

17+00 to 21+00 3127 S.Y.

REMOVAL OF CONCRETE

17+00 to 21+00 380 S.Y.

ADJUST UTILITY APPURTENANCE

17+96.0 Lt. 33.0' W.G.V. 1 Ea.
 18+71.0 Lt. 22.5' W.S.V. 1 Ea.
 18+98.8 Lt. 36.5' W.S.V. 1 Ea.
 19+45.0 Lt. 30.5' W.S.V. 1 Ea.
 19+51.0 Lt. 35.0' W.S.V. 1 Ea.
 20+90.7 Lt. 34.1' W.S.V. 1 Ea.

ADJUST MANHOLE

17+17.0 Rt. 32.8' 1 Ea.
 18+30.5 Rt. 29.0' 1 Ea.
 18+31.0 Lt. 23.5' 1 Ea.

REMOVAL OF CATCH BASINS

17+38 Rt. 36.2' 1 Ea.
 17+85 Lt. 25.0' 1 Ea.

**REMOVAL OF CULVERTS-
ALL TYPE & SIZES**

18+50 Lt. to 18+54.4 Rt. 48"x 86 L.F.

INLET, DOUBLE, TYPE S

⑧ 1 Ea. (See Detail Sheet)

MANHOLE CASTING

17+68 Rt. 25' 1 Ea.

**PIPE, CONC. REINF.
CL. III SEWER**

⑧ to ⑨ 48"x 78 L.F.

NOTE: Engineer in the field shall establish gradients on the 6th Ave. NW curb & gutter (radius portion) as required to direct the drainage north to the existing inlets.

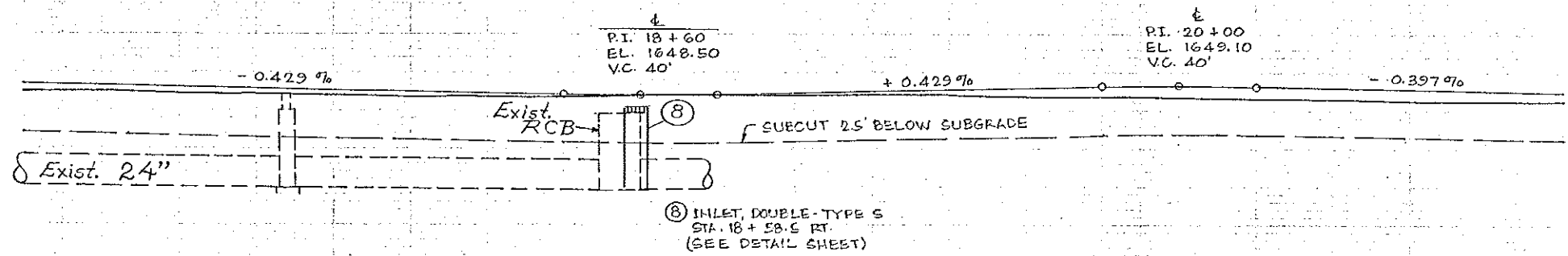

1648.8
1649.19

1648.4
1648.76

1648.5
1648.67

1648.4
1649.06

1648.1
1649.70

FHWA REGION	STATE	FED. AID PROJ. NO.	SHEET NO.
8	N.D.	F-1-094(000)915	

CURB & GUTTER TYPE I

21+00 to 21+88 Lt. 95.4 L.F.
 22+32 to 25+00 Lt. 275.4 L.F.
 21+00 to 25+00 Rt. 400.0 L.F.

DRIVEWAY CONCRETE (H.E.S.)

23+00.5 Lt. 30' 56.9 S.Y.

SIDEWALK, CONCRETE

21+00 to 25+00 Lt. 428.7 S.Y.
 21+00 to 25+00 Rt. 318.7 S.Y.

REMOVAL OF CONCRETE PAVEMENT

21+00 to 25+00 3254 S.Y.

REMOVAL OF CONCRETE

21+00 to 25+00 307 S.Y.

ADJUST UTILITY APPURTENCE

21+06.3 Lt. 33.5' W.S.V. 1 Ea.
 21+62.0 Lt. 34.5' W.S.V. 1 Ea.
 21+70.5 Lt. 22.3' W.G.V. 1 Ea.
 22+40.6 Lt. 37.0' W.G.V. 1 Ea.
 22+72.8 Lt. 34.9' W.S.V. 1 Ea.
 22+92.0 Lt. 34.5' W.S.V. 1 Ea.
 23+08.7 Lt. 34.7' W.S.V. 1 Ea.
 23+80.0 Lt. 34.5' W.S.V. 1 Ea.

ADJUST MANHOLES

21+72.0 Rt. 30.0' 1 Ea.
 22+22.0 Rt. 27.7' 1 Ea.
 22+80.0 Rt. 20.0' 1 Ea.
 24+34 Rt. 35.3' 1 Ea.

REMOVAL OF CATCH BASINS

21+67.0 Lt. 28.5' 1 Ea.

REMOVAL OF MANHOLES

21+72.0 Rt. 30' 1 Ea.
 22+96.0 Rt. 30' 1 Ea.

INLET

(12) 1 Ea.

MANHOLE 48"

(13) 1 Ea. (Curb Inlet Casting)

MANHOLE RISER

(13) 48"x 3.0 L.F.

PIPE, CONC. REINF. CLASS III SEWER

(10) to (11) 24"x 12 L.F.
 (12) to (13) 15"x 56 L.F.

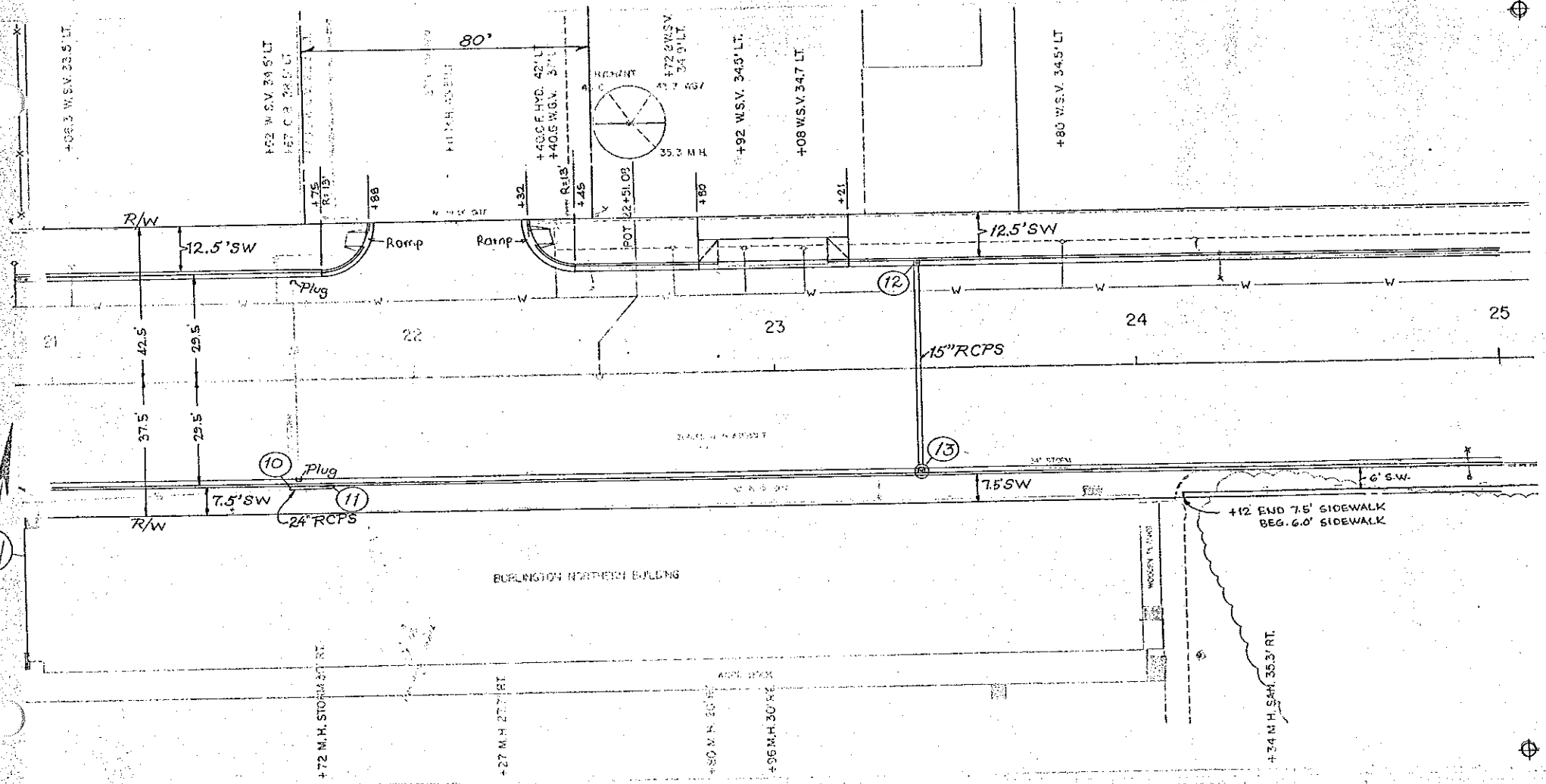

BURLINGTON NORTHERN BUILDING

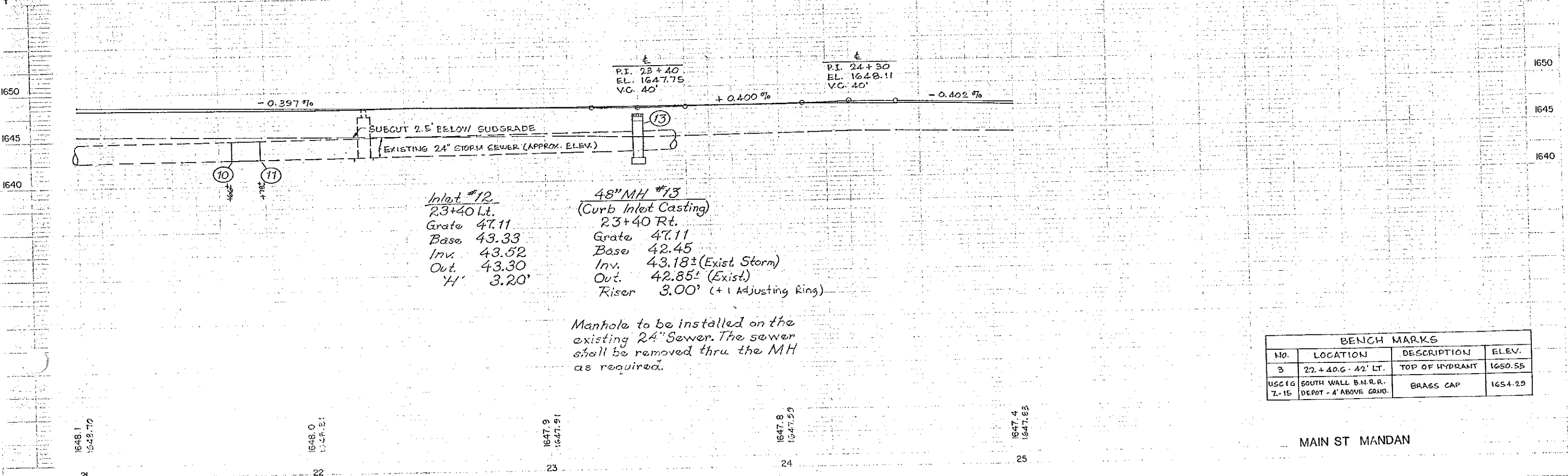
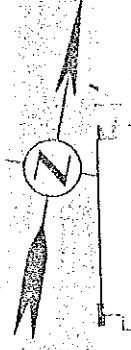

Inlet #12
 23+40 Lt.
 Grate 47.11
 Base 43.33
 Inv. 43.52
 Out. 43.30
 'H' 3.20'

48" MH #13
 (Curb Inlet Casting)
 23+40 Rt.
 Grate 47.11
 Base 42.45
 Inv. 43.18± (Exist Storm)
 Out. 42.85± (Exist)
 Riser 3.00' (+ 1 Adjusting Ring)

Manhole to be installed on the existing 24" Sewer. The sewer shall be removed thru the MH as required.

BENCH MARKS			
NO.	LOCATION	DESCRIPTION	ELEV.
3	22+40.6 - 42' LT.	TOP OF HYDRANT	1650.55
USCEG 7-15	SOUTH WALL B.M.R.R. DEPOT - 4' ABOVE GRD.	BRASS CAP	1654.29

CURB & GUTTER-TYPE I

25+00.0 to 25+69.5 Lt. 76.9 L.F.
 26+13.5 to 29+00.0 Lt. 293.9 L.F.
 25+00.0 to 28+95.0 Rt. 398.7 L.F.

SIDEWALK CONCRETE

25+00 to 29+00 Lt. 485.6 S.Y.
 25+00 to 28+94.5 Rt. 262.1 S.Y.

REMOVAL OF CONCRETE PVM'T.

25+00 to 29+00 2776 S.Y.

REMOVAL OF CONCRETE

25+00 to 29+00 718 S.Y.

ADJUST UTILITY APPURTENANCE

25+84.0 Lt. 22' W.G.V. 1 Ea.
 25+94.0 Lt. 22.5' W.G.V. 1 Ea.
 26+21.0 Lt. 29.5' W.G.V. 1 Ea.
 26+80.5 Lt. 32.0' W.S.V. 1 Ea.
 27+62.0 Lt. 31.5' W.S.V. 1 Ea.
 27+85.0 Lt. 19.0' W.G.V. 1 Ea.
 28+73.5 Lt. 31.7' W.G.V. 1 Ea.

ADJUST MANHOLES

25+87.0 Rt. 35.3' 1 Ea.
 25+97.0 Rt. 31.5' 1 Ea.

REMOVAL OF CATCH BASINS

25+46.0 Lt. 28' 1 Ea.
 28+72.5 Rt. 29' 1 Ea.
 28+74.5 Lt. 28' 1 Ea.

TREE GRATES

28+40.0 LT. 1EA.
 28+85.0 LT. 1EA.

INLETS

14 1 Ea.

16 1 Ea.

INLET, CURB CASTING

25+48 Rt. 1 Ea.

PIPE, CONC. REINF.

CL. III SEWER

14 to 15 12"x 6 L.F.

16 to 17 12"x 6 L.F.

18 to 19 18"x 8 L.F.

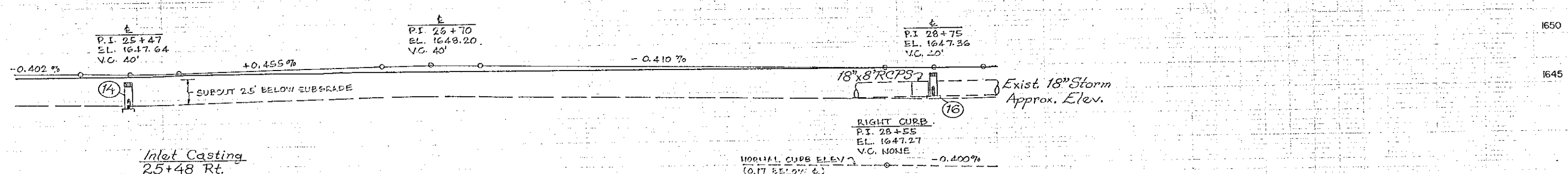
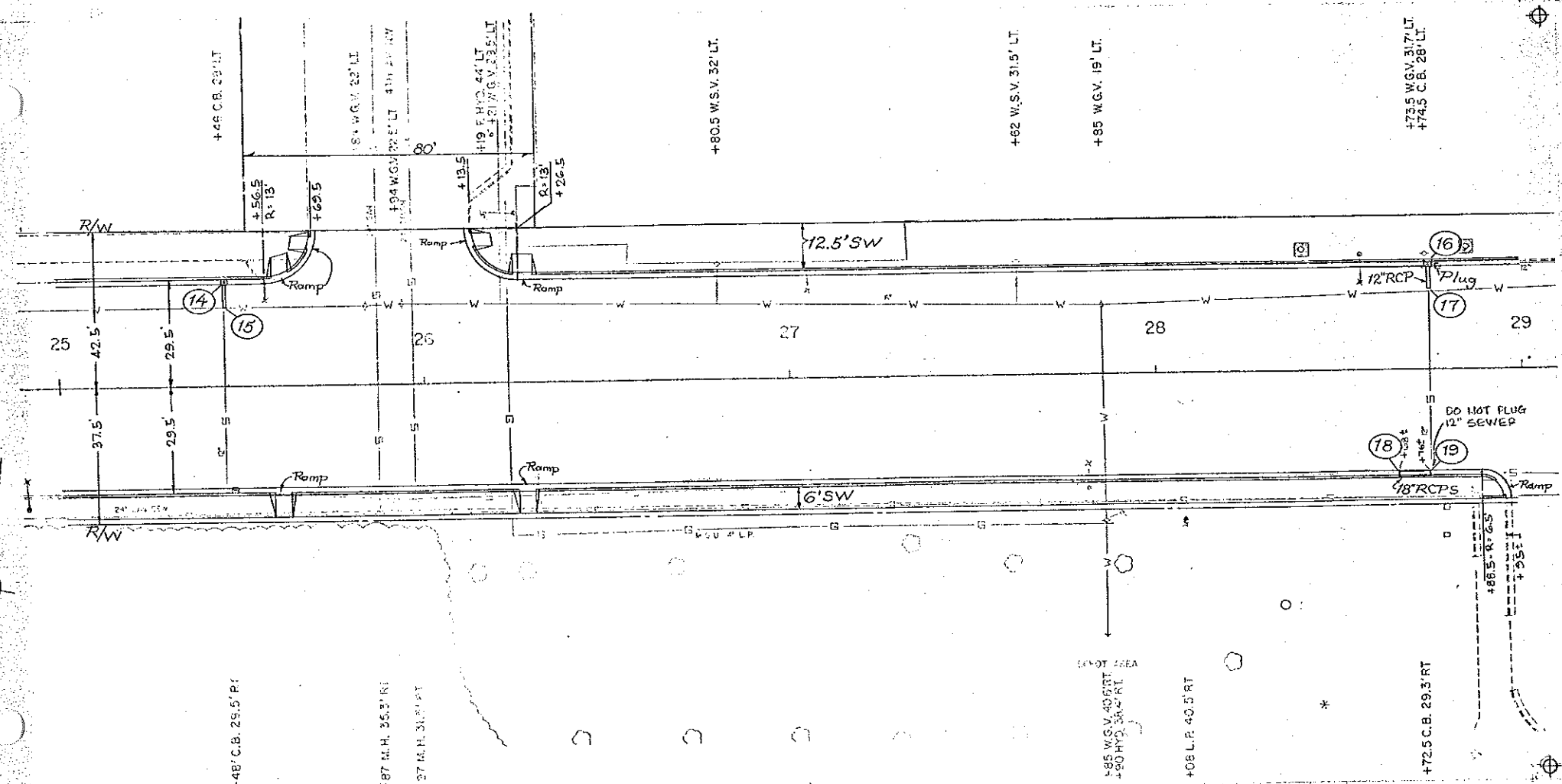

Inlet Casting
 25+48 Rt.
 Grate 46.88

Inlet # & Type	#14-Inlet	#16-Inlet
Sta.	25+46 Lt.	28+74.5 Lt.
Grate	46.88	46.72
Base	43.82	43.94
Inn.	44.15± (Exist.)	44.38± (Exist.)
Out.	(Exist.)	(Exist.)
H'	2.60'	2.20'

Inlets #14 & #16 to be installed over the existing 12" RCP sewer. The 12" x 6" W.S. sewer that has been provided will be used only if required in making these installations.

1647.4
1647.03

1647.5
1647.03

1647.4
1647.03

1647.3
1647.67

1647.2
1647.46

FHWA REGION	STATE	FED. AID PROJ. NO.	SHEET NO.
8	N.D.	F-1-094(006)915	

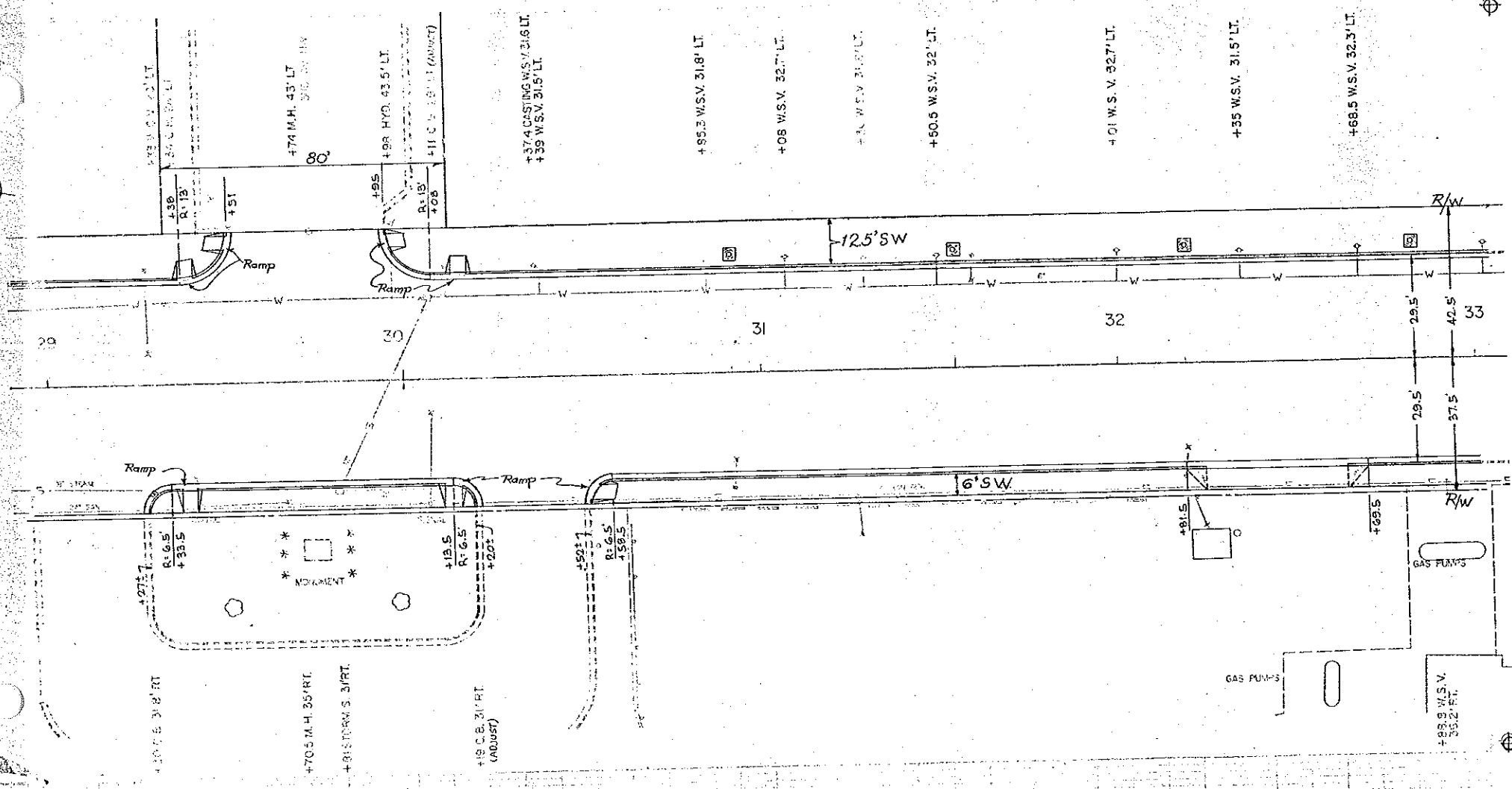

CURB & GUTTER-TYPE I

- 29+00 to 29+51 Lt. 58.4 L.F.
- 29+95 to 33+00 Lt. 312.4 L.F.
- 29+27 to 30+20 Rt. 100.4 L.F.
- 30+52 to 33+00 Rt. 251.7 L.F.

DRIVEWAY, CONCRETE (H.E.S.)

- 32+44 Rt. 40' 34 S.Y.

SIDEWALK, CONCRETE

- 29+00 to 33+00 Lt. 485.6 S.Y.
- 29+27.5 to 33+00 Rt. 190.6 S.Y.

REMOVAL OF CONC.PVM'T.

- 29+00 to 33+00 2818 S.Y.

REMOVAL OF CONCRETE

- 29+00 to 33+00 676 S.Y.

ADJUST UTILITY APPURTENANCE

- 29+33.0 Lt. 23.0' W.G.V. 1 Ea.
- 30+37.4 Lt. 31.6' W.S.V. 1 Ea.
- 30+39.0 Lt. 31.5' W.S.V. 1 Ea.
- 30+85.3 Lt. 31.8' W.S.V. 1 Ea.
- 31+08.0 Lt. 32.7' W.S.V. 1 Ea.
- 31+30.0 Lt. 31.8' W.S.V. 1 Ea.
- 31+50.5 Lt. 32.0' W.S.V. 1 Ea.
- 32+01.0 Lt. 32.7' W.S.V. 1 Ea.
- 32+35.0 Lt. 31.5' W.S.V. 1 Ea.
- 32+68.5 Lt. 32.5' W.S.V. 1 Ea.
- 32+88.8 Rt. 36.2' W.S.V. 1 Ea.

TREE GRATES

- 30+91.0 LT. 1EA.
- 31+94.0 LT. 1EA.
- 32+19.0 LT. 1EA.
- 32+83.0 LT. 1EA.

ADJUST MANHOLES

- 29+70.5 Rt. 35.0' 1 Ea.
- 29+81.0 Rt. 31.0' 1 Ea.
- * 30+11.0 Lt. 29.5' 1 Ea.
- * 30+19.0 Rt. 31.5' 1 Ea.

* Inlets, adjustment paid for at price bid for "ADJUST MANHOLES"

REMOVAL OF CATCH BASINS

- 29+34 Lt. 28' 1 Ea.

INLET, CURB CASTING

- 29+30 Rt. 31.8' 1 Ea.

P.I. 31+40
EL. 1648.40
V.C. 40'

RIGHT CURB
P.I. 31+80
EL. 1648.06
V.C. 40'

NORMAL CURB ELEV. AHD.
(0.17') BELOW E

+0.392 %
SUBCUT 2.5' BELOW SUBGRADE

+0.436 %

-0.422 %

RIGHT CURB
P.I. 29+30
EL. 1646.97
V.C. 40'

Inlet Casting
29+30 Rt. 31.8' ± Rt.
Grate 46.30 ±

STA. 11+00 TO 48+57
EXC. 22,325 C.Y.
EMB. 642 C.Y.
WASTE 31,703 C.Y. (SEE NOTE 200-P05)

1647.2
1647.46

1647.3
1647.85

1647.4
1648.24

1647.6
1648.15

1647.6
1648.75

FHWA REGION	STATE	FED. AID PROJ. NO.	SHEET NO.
8	N.D.	F-1-094(006) 915	

CURB & GUTTER-TYPE I

33+00 to 33+32.5 Lt. 39.9 L.F.
 33+76.5 to 37+00.5 Lt. 331.4 L.F.
 33+00.0 to 37+00.0 Rt. 400 L.F.

DRIVEWAY, CONCRETE (H.E.S.)

33+39.5 Rt. (40') 34.0 S.Y.
 34+12.0 Rt (26') 24.7 S.Y.
 35+53.5 Rt. (14') 16.7 S.Y.

SIDEWALK, CONCRETE

33+00 to 37+00.5 Lt. 486.3 S.Y.
 33+00 to 37+00.0 Rt. 191.3 S.Y.

REMOVAL OF CONC. PVM'T.

33+00 to 37+00 2810 S.Y.

REMOVAL OF CONCRETE

33+00 to 37+00 670 S.Y.

ADJUST UTILITY APPURTENANCE

33+02.0 Lt. 33.0' W.S.V. 1 Ea.
 43+41.0 Lt. 31.3' W.S.V. 1 Ea.
 34+48.0 Lt. 31.0' W.S.V. 1 Ea.
 34+81 Lt. 31.2' W.S.V. 1 Ea.
 35+10 Lt. 31.6' W.S.V. 1 Ea.
 35+45 Lt. 32.2' W.S.V. 1 Ea.
 35+89 Lt. 32.5' W.S.V. 1 Ea.
 36+32 Lt. 32.2' W.S.V. 1 Ea.
 36+50 Lt. 32.0' W.S.V. 1 Ea.

ADJUST MANHOLES

33+50.0 Rt. 35.0' 1 Ea.
 36+03.0 Lt. 31.3' 1 Ea.
 36+03.5 Rt. 35.0' 1 Ea.

REMOVAL OF CATCH BASINS

36+97 Lt. 29' 1 Ea.

INLETS

(20) 1 Ea.
 (21) 1 Ea.
 (22) 1 Ea.
 (24) 1 Ea.

INLETS, SPECIAL

(23) 1 Ea.
 (See Detail Sheet)

INLET, CURB CASTING

36+96.5 Rt. 1 Ea.

MANHOLE CASTING

33+61 Rt. 29' 1 Ea.

PIPE, CONC. REINF, CL. III SEWER

(20) to (21) 15"x 56 L.F.
 (21) to (21A) 15"x 54 L.F.
 (22) to (23) 15"x 92 L.F.
 (24) to (25) 12"x 6 L.F.

TREE GRATES

35+05.0 LT. 1EA.
 36+25.0 LT. 1EA.

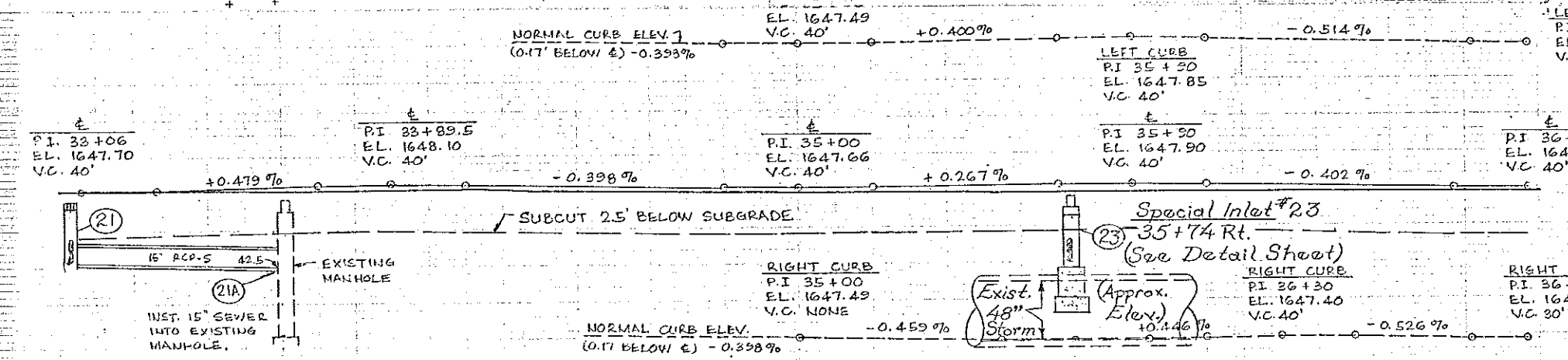
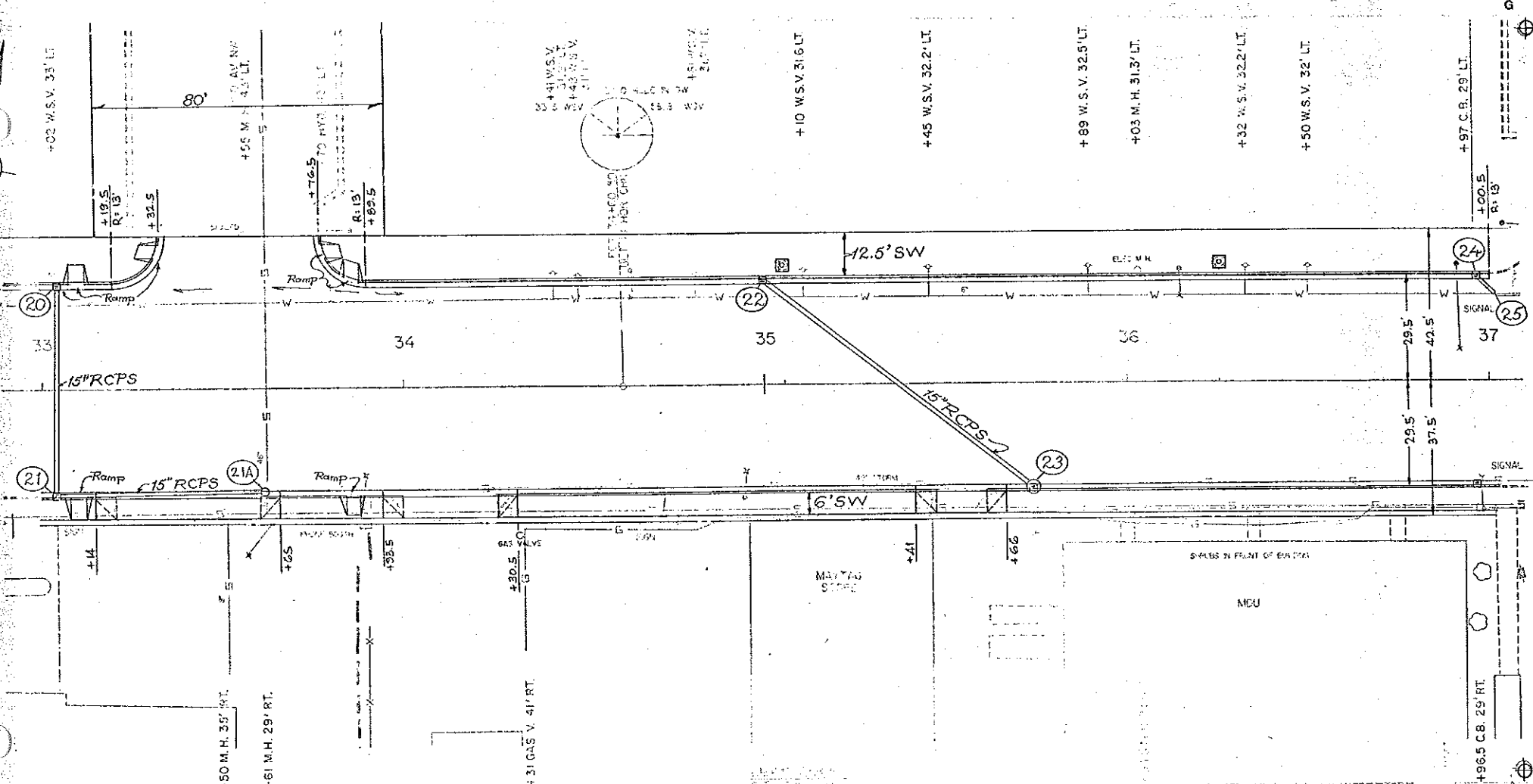

Inlet # & Type	Sta.	Grate	Base	Inv.	Out.	H'
#20-Inlet	33+03 Lt.	47.06	43.08	43.27	42.87	3.40'
#21-Inlet	33+03 Rt.	47.06	42.68	42.87	42.50	3.80'
#22-Inlet	35+00 Lt.	47.02	42.94	43.13	42.60±	3.50'
#24-Inlet	36+97 Lt.	46.82	41.64±	42.02±(Exist.)	Existing	4.60'

(INST. OVER EXISTING 12" RCP SEWER)

BENCH MARK			
NO.	LOCATION	DESCRIPTION	ELEV.
4	33+79-45' LT.	TOP OF HYDRANT	1650.02

MAIN ST MANDAN

1647.6
1647.75
33

1647.6
1648.05
34

1647.4
1647.65
35

1647.3
1647.95
36

1647.2
1647.55
37

FHWA REGION	STATE	FED. AID PROJ. NO.	SHEET NO.
8	N.D.	F-1-034(006) 915	

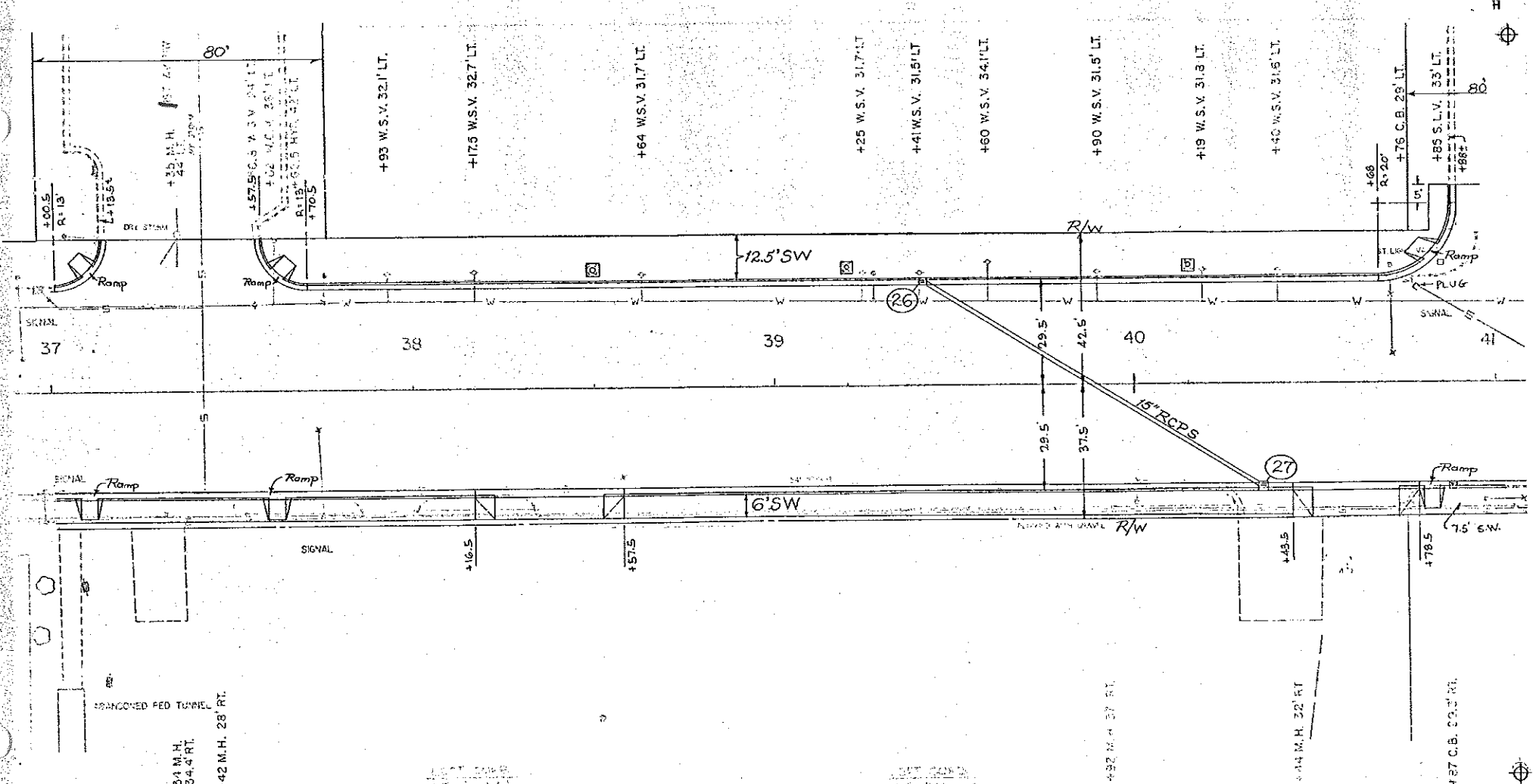

CURB & GUTTER TYPE I

37+00.5 to 37+13.5 Lt. 20.4 L.F.
 37+57.5 to 40+88.0 Lt. 354.3 L.F.
 37+00.0 to 41+00.0 Rt. 400.0 L.F.

DRIVEWAY, CONCRETE (H.E.S.)

38+37 Rt. (30') 27.3 S.Y.
 40+61 Rt. (24') 29.2 S.Y.

SIDEWALK, CONCRETE

37+00.5 to 40+87.5 Lt. 465.7 S.Y.
 37+00.0 to 41+00.0 Rt. 219.6 S.Y.

REMOVAL OF CONCRETE PVM'T.

27+00 to 41+00 2858 S.Y.

REMOVAL OF CONCRETE

37+00 to 41+00 622 S.Y.

ADJUST UTILITY APPURTENANCE

37+56.8 Lt. 24.0' W.G.V. 1 Ea.
 37+62.0 Lt. 36.0' W.G.V. 1 Ea.
 37+93.0 Lt. 32.1' W.S.V. 1 Ea.
 38+17.5 Lt. 32.7' W.S.V. 1 Ea.
 38+64.0 Lt. 31.7' W.S.V. 1 Ea.
 39+25.0 Lt. 31.7' W.S.V. 1 Ea.
 39+41.0 Lt. 31.5' W.S.V. 1 Ea.
 39+60.0 Lt. 34.1' W.S.V. 1 Ea.
 39+90.0 Lt. 31.5' W.S.V. 1 Ea.
 40+19.0 Lt. 31.8' W.S.V. 1 Ea.
 40+40.0 Lt. 31.6' W.S.V. 1 Ea.

TREE GRATES

38+50.0 Lt. 1EA.
 39+20.0 Lt. 1EA.
 40+15.0 Lt. 1EA.

ADJUST MANHOLES

37+34 Rt. 34.4' 1 Ea.
 37+42 Rt. 28' 1 Ea.
 40+44 Rt. 32' 1 Ea.

REMOVAL OF CATCH BASINS

39+92 Rt. 37' 1 Ea.
 40+44 Rt. 32' 1 Ea.
 40+76 Lt. 29' 1 Ea.

INLETS

(26) 1 Ea.

INLETS, SPECIAL

(27) 1 Ea.
 (See Detail Sheet)

INLET, CURB CASTING

40+87 Rt. 29.5' 1 Ea.

PIPE, CONC. REINF. CL. III SEWER

(26) to (27) 15"x 106 L.F.

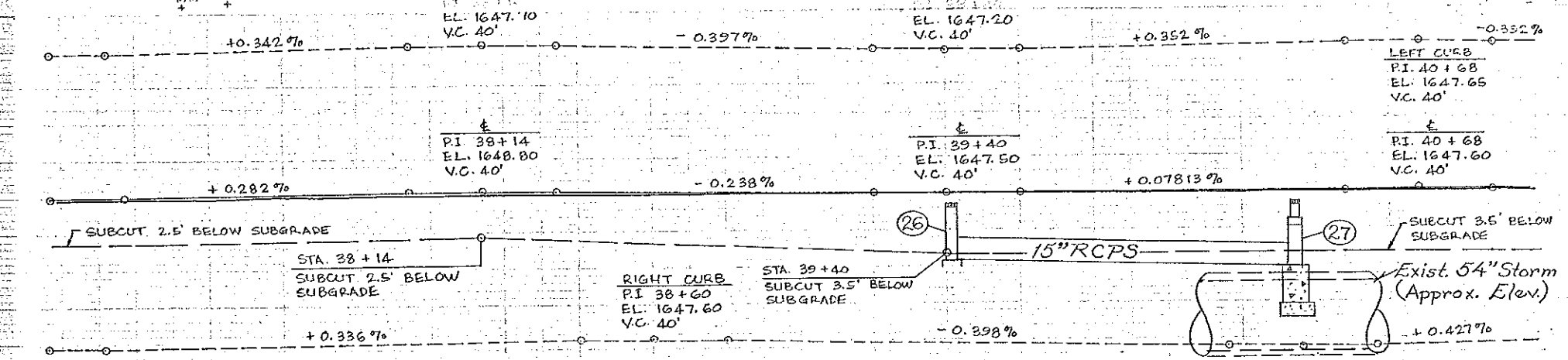

#26-Inlet
 39+41.2 Lt.
 Grate 46.72
 Base 42.64
 Inv. 42.83
 Out. 42.20
 'H' 3.50'

#27 Special Inlet
 40+35.3 Rt.
 (See Detail Sheet)

Inlet Casting
 40+87 Rt.
 Grate 46.61

SEE DETAIL SHEET FOR INLET CASTING

BENCH MARK			
NO.	LOCATION	DESCRIPTION	ELEV.
5	37+62.5-42' LT.	TOP OF HYDRANT	1650.02

MAIN ST MANDAN

1647.2
1647.52
37

1647.3
1647.76
38

1647.3
1647.59
39

1647.2
1647.55
40

1647.2
1647.54
41

FHW A REGION	STAFF	FED. AID PROJ. NO.	SHEET NO.
8	N.D.	F-1-094(006)915	

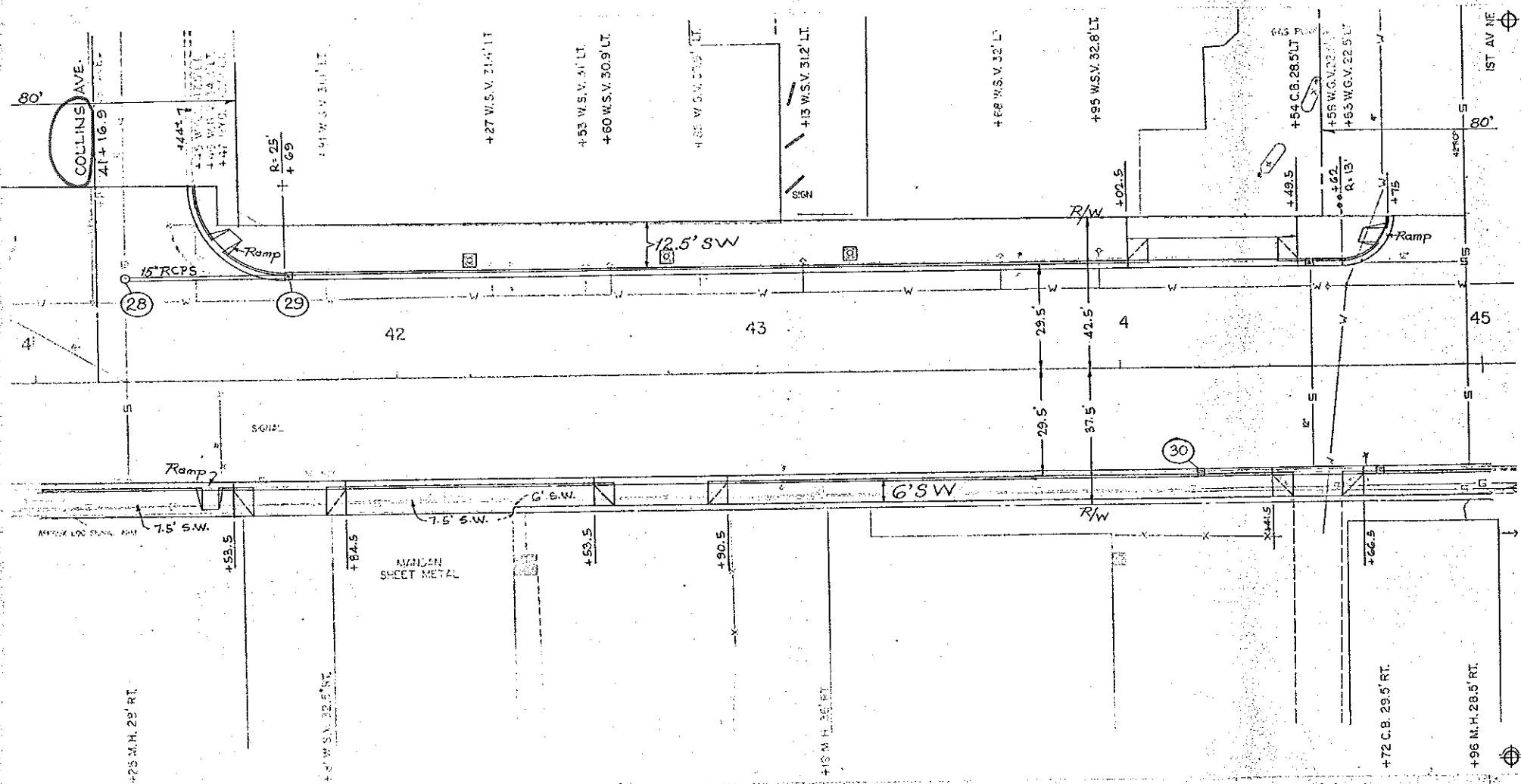

CURB & GUTTER-TYPE I

41+44 to 44+75 Lt. 352.7 L.F.
41+00 to 45+00 Rt. 400.0 L.F.

DRIVEWAY, CONCRETE (H.E.S.)

41+69 Rt. (20') 25.8 S.Y.
42+72 Rt. (26') 24.7 S.Y.
44+26 Lt. (36') 24.7 S.Y.
44+26 Rt. (36') 65.3 S.Y.
44+54 Rt. (14') 16.7 S.Y.

SIDEWALK, CONCRETE

41+44.5 to 44+74.5 Lt. 386.1 S.Y.
41+00 to 45+00 Rt. 221.4 S.Y.

REMOVAL OF CONC. PVM'T.

41+00 to 45+00 2940 S.Y.

REMOVAL OF CONCRETE

41+00 to 45+00 621 S.Y.

ADJUST UTILITY APPURTENANCE

41+16 Lt. 22.5' W.G.V. 1 Ea.
41+45 Lt. 47.5' W.G.V. 1 Ea.
41+46 Lt. 34.9' W.G.V. 1 Ea.
41+81 Lt. 31.1' W.S.V. 1 Ea.
41+81 Rt. 32.5' W.S.V. 1 Ea.
42+27 Lt. 31.4' W.S.V. 1 Ea.
42+53 Lt. 31.0' W.S.V. 1 Ea.
42+60 Lt. 30.9' W.S.V. 1 Ea.
42+85 Lt. 30.9' W.S.V. 1 Ea.
43+13 Lt. 31.2' W.S.V. 1 Ea.
43+68 Lt. 32.0' W.S.V. 1 Ea.
43+95 Lt. 32.8' W.S.V. 1 Ea.
44+58 Lt. 22.5' W.G.V. 1 Ea.
44+63 Lt. 22.5' W.G.V. 1 Ea.

ADJUST MANHOLES

41+17 Lt. 42' 1 Ea.
41+25 Rt. 28' 1 Ea.
43+19 Rt. 36' 1 Ea.
44+96 Rt. 28.5' 1 Ea.

INLETS

(29) 1 Ea.

INLETS, SPECIAL

(28) 1 Ea.
(30) 1 Ea.

INLET, CURB CASTING

44+54 Lt. 1 Ea.
44+72 Rt. 1 Ea.

PIPE, CONC. REINF. CL. III SEWER

(28) to (29) 15'x 42 L.F.

TREE GRATES

42+20.0 LT. 1EA.
42+75.0 LT. 1EA.
43+25.0 LT. 1EA.

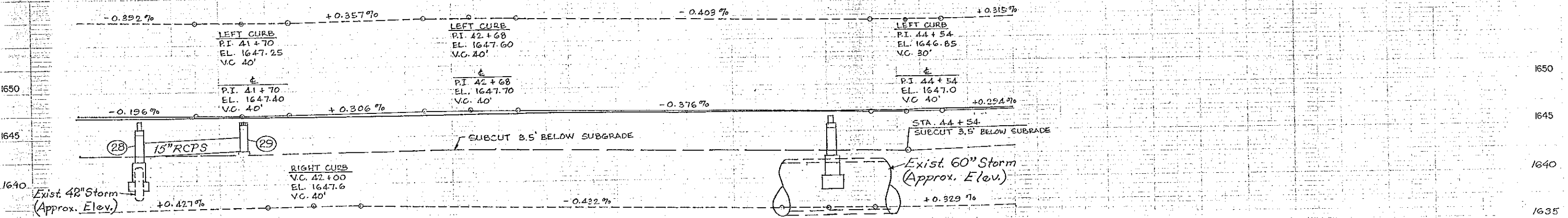

#28-Special Inlet
41+25-29' Lt.
(See Detail Sheet)

#29-Inlet
41+70 Lt.
Grate 46.78
Base 43.40
Inv. 43.59
Out. 43.20
'H' 2.80'

#30 Special Inlet
44+72 Rt.
(See Detail Sheet)

Inlet Casting
44+54 Lt.
grate EL. 1646.37

Inlet Casting
44+72 Rt.
Grate EL. 1646.31

BENCH MARK			
NO.	LOCATION	DESCRIPTION	ELEV.
6	41+47 - 49.5' LT.	TOP OF HYDRANT	1649.71

FHWA REGION	STATE	FED. AID PROJ. NO.	SHEET NO.
8	N.D.	F-1-094(006)915	

JOINT NO.	FULL DEPTH REPAIR		SPALL REPAIR		RANDOM CRACK LF
	DIMENSIONS	SF	DIMENSIONS	SF	
1					24
2			1.5 x 3	4.50	
3					

CURB & GUTTER-TYPE I

45+19 to 48+58 Lt. 363.8 L.F.
45+00 to 48+46 Rt. 346.5 L.F.

ADJUST UTILITY APPURTENANCE

45+73 Lt. 31' W.S.V. 1 Ea.
46+01 Lt. 31.8' W.S.V. 1 Ea.
46+43 Lt. 31.5' W.S.V. 1 Ea.
46+69.5 Lt. 31' W.S.V. 1 Ea.
47+11 Lt. 33' W.S.V. 1 Ea.
47+50 Lt. 30.6' W.S.V. 1 Ea.
48+21 Lt. 30.7' W.S.V. 1 Ea.

DRIVEWAY, CONCRETE (H.E.S.)

45+48.5 Rt. (18') 19.3 S.Y.
46+87.5 Rt. (30') 27.3 S.Y.

SIDEWALK, CONCRETE

45+19.5 to 48+58 Lt. 462.0 S.Y.
45+00.0 to 48+46 Rt. 183.7 S.Y.

ADJUST MANHOLES

45+09 Rt. 34.7' 1 Ea.

REMOVAL OF CONC. PVM'T.

45+00 to 48+57 2492 S.Y.

REMOVAL OF CONCRETE

45+00 to 48+58 637 S.Y.

TREE GRATES

46+23.0 LT. 1EA.
47+00.0 LT. 1EA.

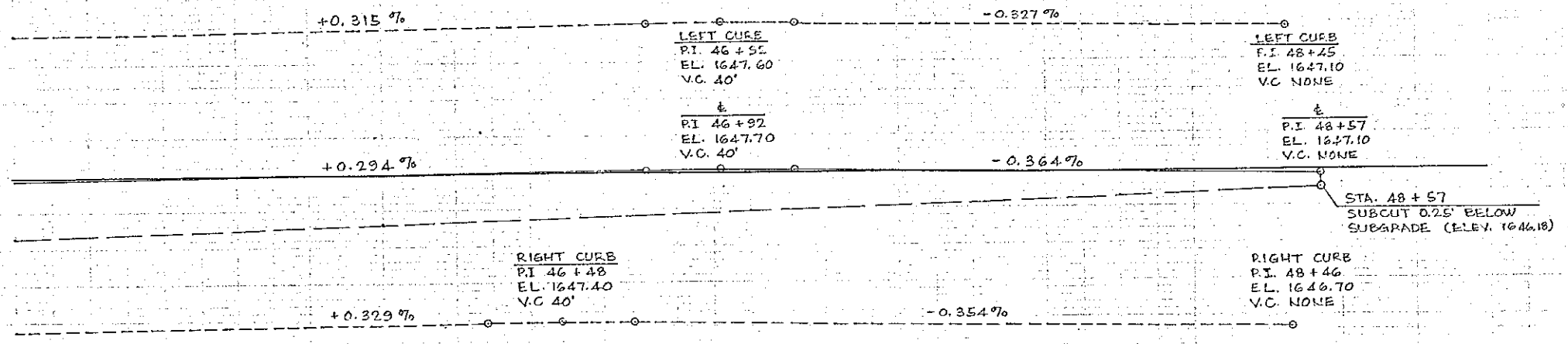
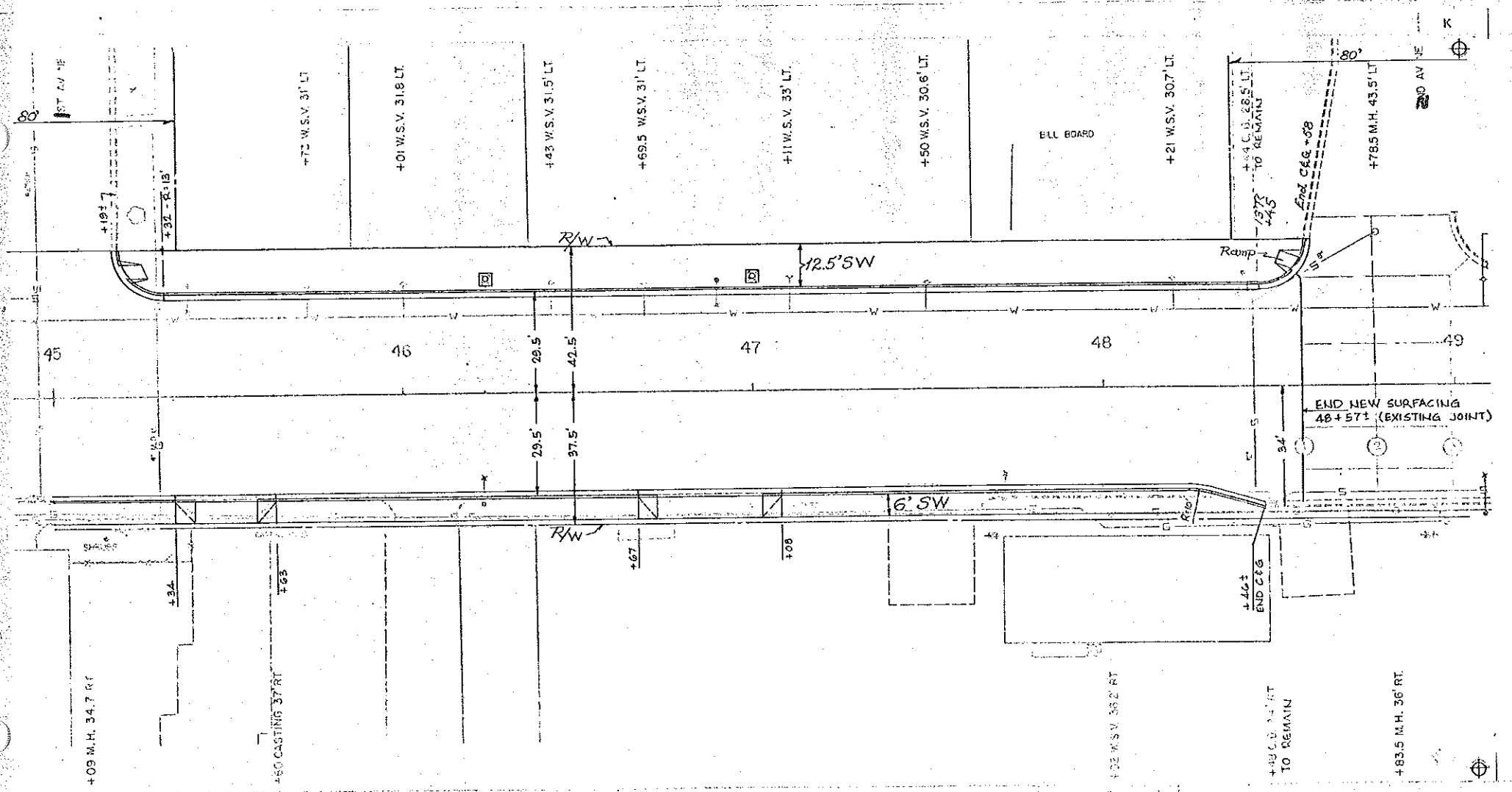

NOTE: SUBGRADE IS 0.67' (8") BELOW FINISH GRADE.

1647.2
1647.14
45

1647.2
1647.43
46

1647.2
1647.66
47

1647.1
1647.31
48

1647.1
49

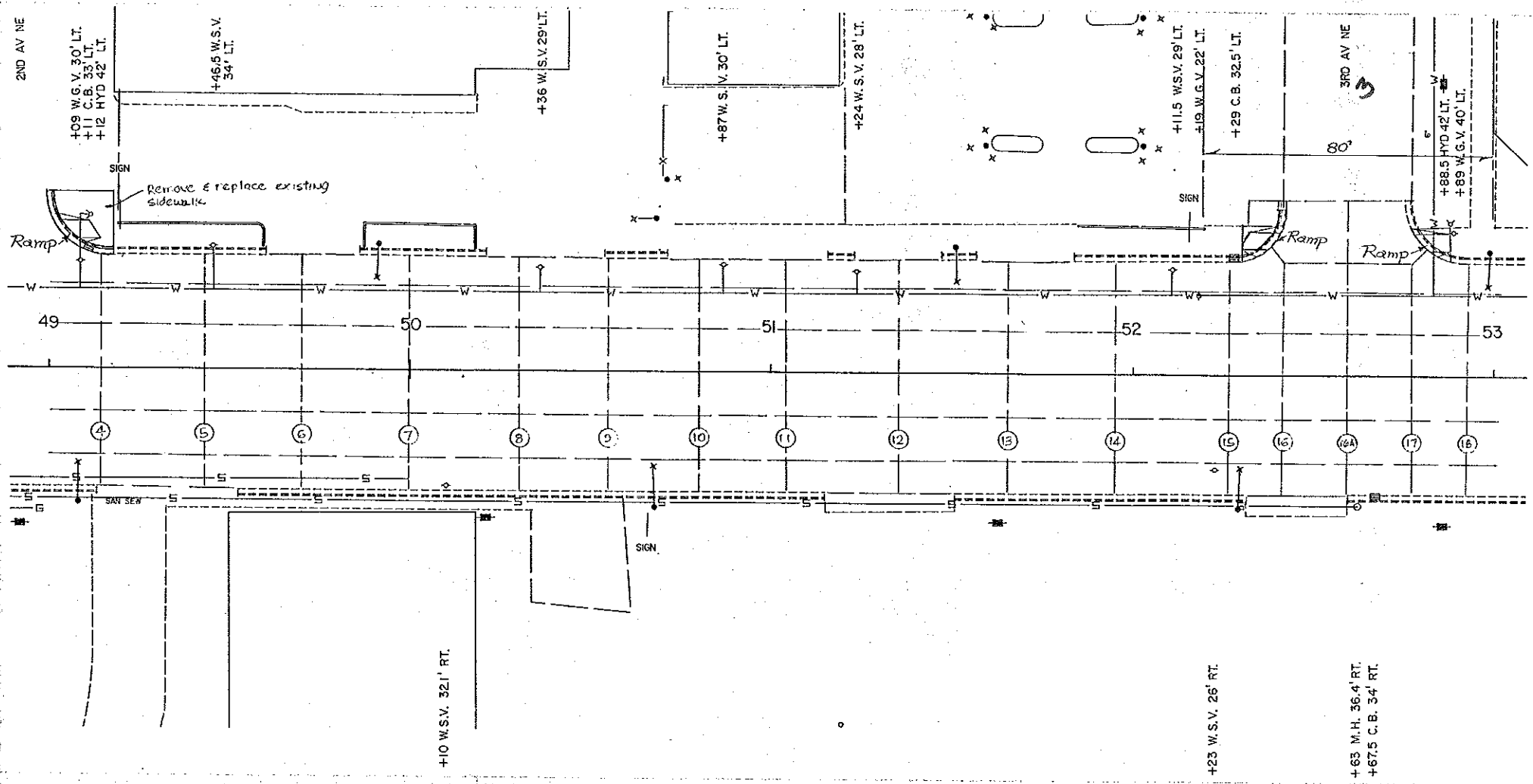

JOINT NO.	FULL DEPTH REPAIR		SPALL REPAIR		RANDOM CRACK
	DIMENSIONS	S.F.	DIMENSIONS	SF	
1					
* 4	4 x 65	260			
5			1.5 x 1.5	2.25	
6			2 x 3, 1.5 x 2, 1.5 x 1.5, 1.5 x 2	14.25	66
* 6	6 x 65	396			
7			3 @ 2 x 2, 2 x 3, 2 x 4	26.00	
8					20
9					
10			1.5 x 1.5, 2 x 1.5, 2 x 3, 4 x 4	48.25	
					33
11			1.5 x 4, 4 x 7, 1.5 x 2	37.00	
* 8	8 x 65	520			
12			4 x 8	32.00	
					33
13			2 x 4, 2 x 8, 4 x 4, 1.5 x 2	43.00	
* 4	4 x 33	132			
14			1.5 x 2, 5 x 6, 2 x 6, 2 x 2	49.00	
* 10	10 x 65	650			
15			3 x 5	15.00	
16					
16A					
17			2 x 4, 2 x 4, 1.5 x 8, 1.5 x 1.5	22.75	
18					
* 5	5 x 33	165			33

** CONCRETE PAVEMENT REPAIR (FULL DEPTH)
* JOINT REPAIR (FULL DEPTH)

REMOVAL OF CONCRETE
2ND AVE. N.E. - 30 S.Y. 1650
3RD AVE. N.E. - 30 S.Y.
CURB & GUTTER - TYPE I
2ND AVE. N.E. - 27 L.F. 1645
3RD AVE. N.E. - 37 L.F.
SIDEWALK, CONCRETE
2ND AVE. N.E. - 24 S.Y.
3RD AVE. N.E. - 21 S.Y.

BENCH MARK			
NO.	LOCATION	DESCRIPTION	ELEV.
7	49+12 - 42' LT.	TOP OF HYDRANT	1649.82

1647.1 49 1647.1 50 1647.2 51 1646.7 52 1646.1 53

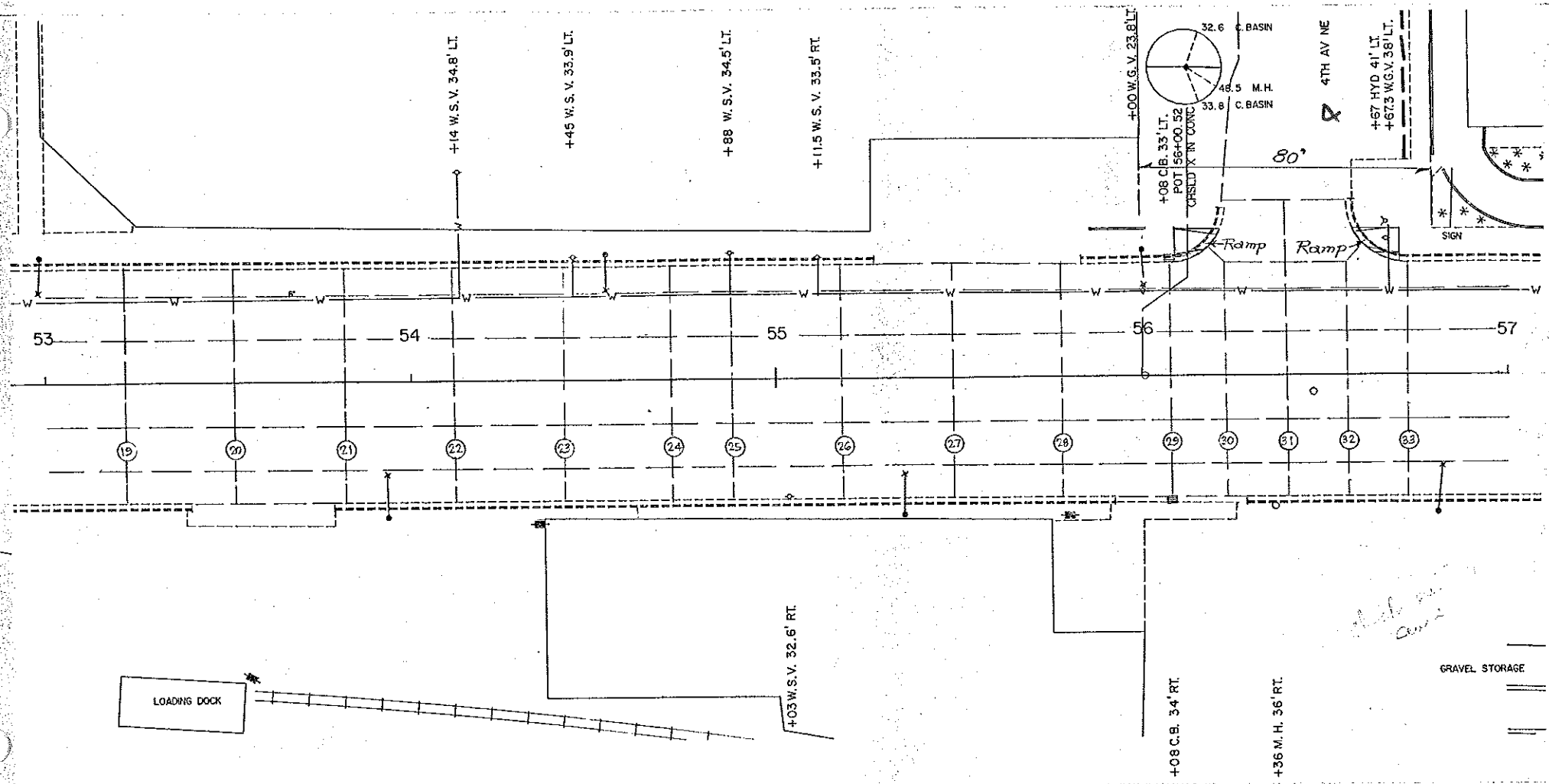

JOINT NO.	FULL DEPTH REPAIR		SPALL REPAIR		RANDOM CRACK LF
	DIMENSIONS	SF	DIMENSIONS	SF	
19			2 x 3, 5 x 5	31.00	
* 20	4 x 33	132	1.5 x 2	3.00	
21					12
* 22	4 x 65	260			
23			2 x 4, 2 x 2, 1.5 x 2	15.00	12
24			1.5 x 12	18.00	33 45
25			3 x 12, 2 x 2	40.00	
26					36
27					57
* 28	4 x 33	132			
* 29	6 x 65	390	3 x 4, 1.5 x 2	15.00	
30			2 x 4	8.00	
31					
32			1.5 x 1.5	2.25	
33			2 x 2	4.00	
* 34	4 x 33 6 x 33	132 198			

* JOINT REPAIR (FULL DEPTH)

- REMOVAL OF CONCRETE
4TH AVE N.E. - 21 S.Y.
- CURB & GUTTER - TYPE I
4TH AVE. N.E. - 32 L.F.
- SIDEWALK, CONCRETE
4TH AVE. N.E. - 14 S.Y.

1650
1645

BENCH MARK			
NO.	LOCATION	DESCRIPTION	ELEV.
8	56 + 07 - 41' LT.	TOP OF HYDRANT	1648.17

MAIN ST MANDAN

1646.1 53
1645.7 54
1645.3 55
1645.1 56
1645.3 57

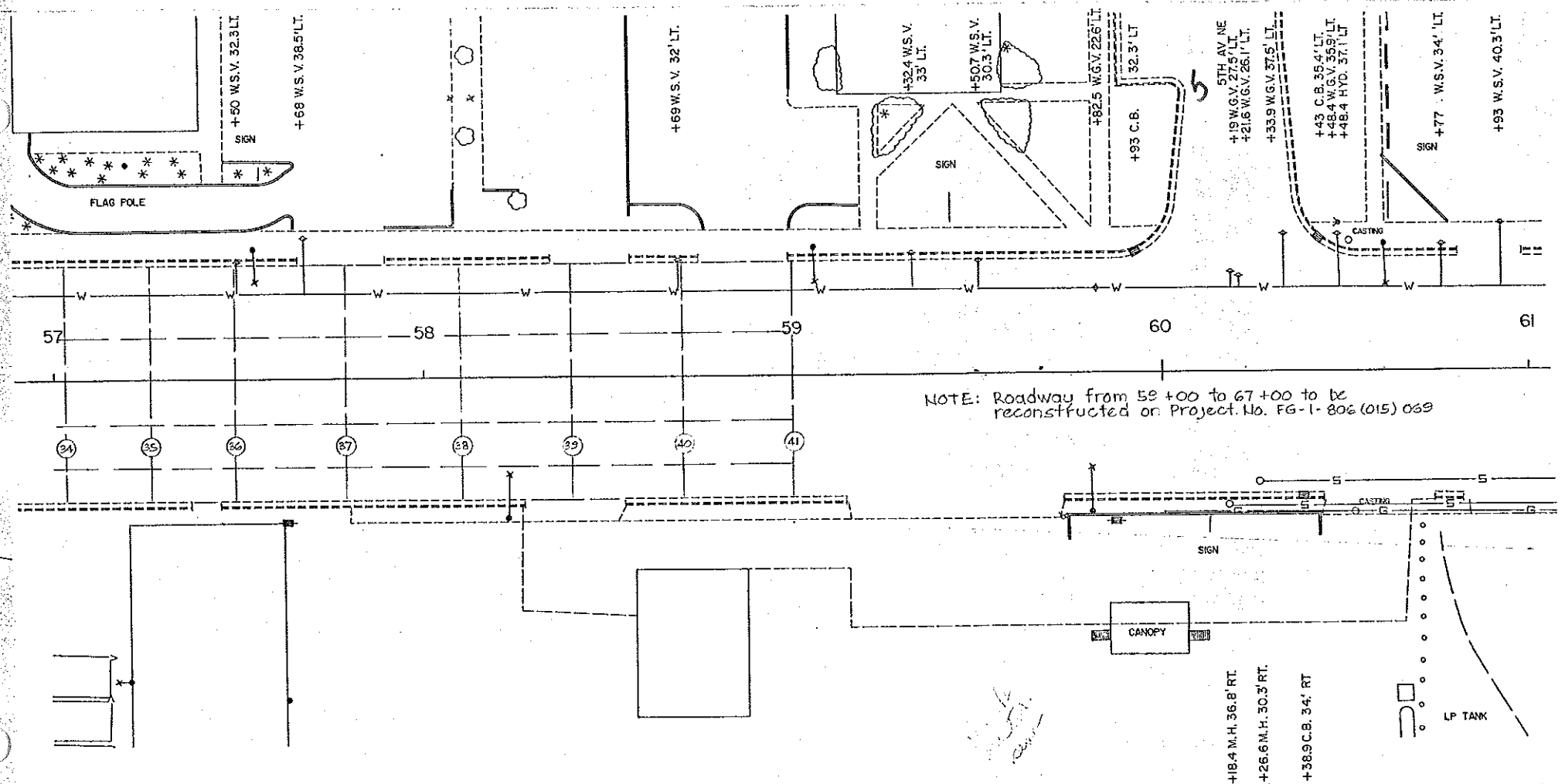

NOTE: Roadway from 59+00 to 67+00 to be reconstructed on Project No. FG-1-806(015)069

STA. 48+57 TO 88+20
SUBCUT EXC. 1563 C.Y. (WASTE)
(SEE NOTE 200-POS)

JOINT NO.	FULL DEPTH REPAIR		SPALL REPAIR		RANDOM CRACK LF
	DIMENSIONS	SF	DIMENSIONS	SF	
35			2 x 3	6.00	
26			1.5 x 2, 2 x 2	7.00	66
37			1.5 x 1.5	2.25	
*	4 x 65	260			
38			2 x 8, 4 x 12, 1.5 x 8, 3 x 3	85.00	
39			4 x 2.4	96.00	
*	4 x 58	232			
40			1.5 x 1.5	2.25	
41			2 x 13	26.00	33

* JOINT REPAIR (FULL DEPTH)

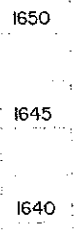
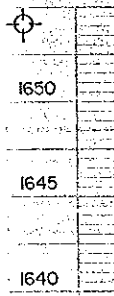

BENCH MARK			
NO.	LOCATION	DESCRIPTION	ELEV.
9	60+62 - 47.2' LT.	S.W. COR. CONC. FOR DONUT SIGN	1645.29

MAIN ST. MANDAN

1645.3 57
1645.1 58
1644.8 59
1644.5 60
1644.7 61

FHW A PROJECT	STATE	FED. AID PROJ. NO.	SHEET NO.
8	N.D.	F-1-094(006)915	

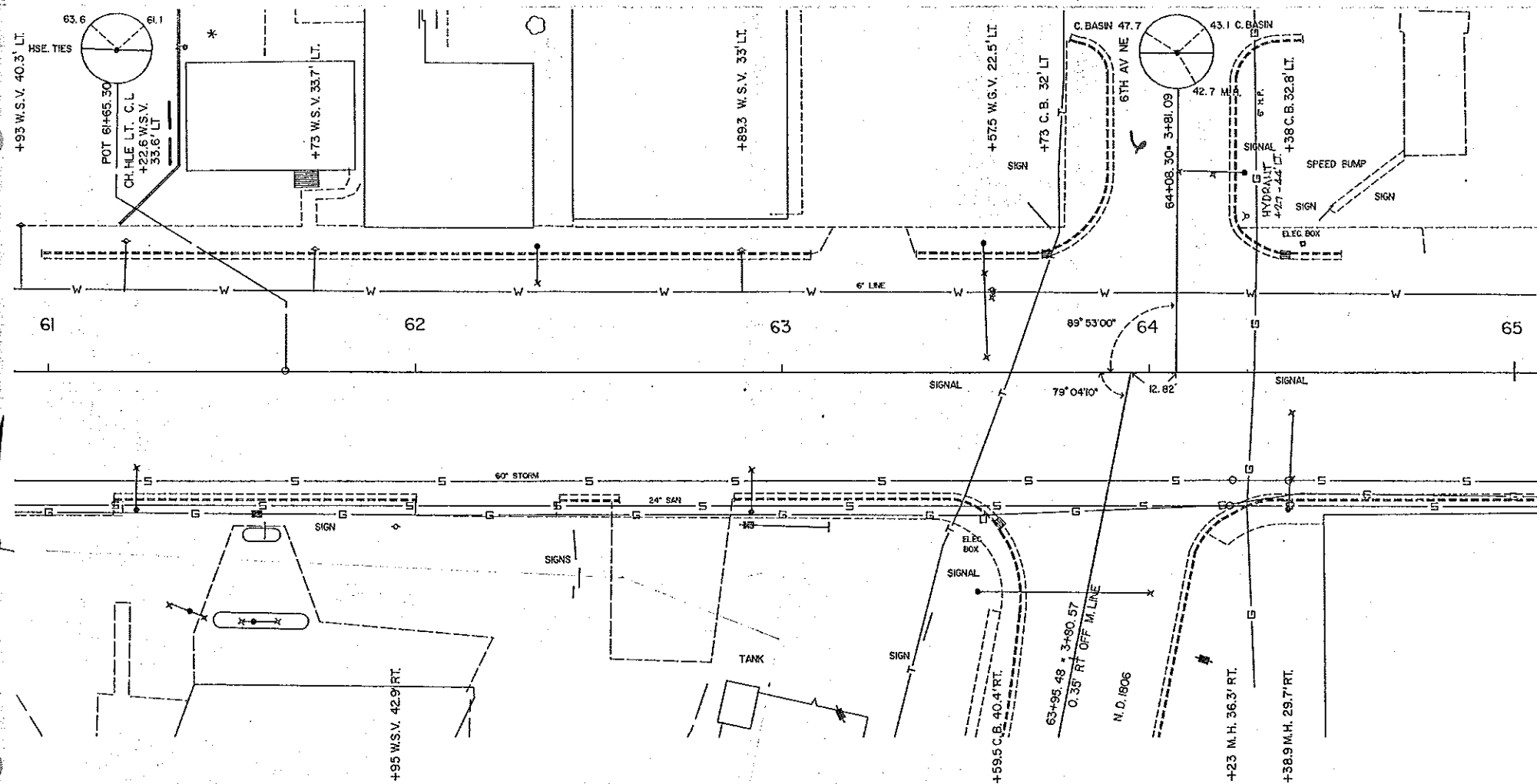

NOTE: The roadway shown on this sheet to be reconstructed on Project FA-1-806(015)069

1650
1645
1640

1650
1645
1640

BENCH MARK			
NO.	LOCATION	DESCRIPTION	ELEV.
Y486	63+33-227' RT.	BRASS CAP ON TOP N. SIDE OF R.R. BRIDGE	1649.04
10	64+27-44' LT.	TOP OF HYDRANT	1647.27

MAIN ST MANDAN

1644.7
1644.7
1644.5
1644.0
1643.8

61 62 63 64 65

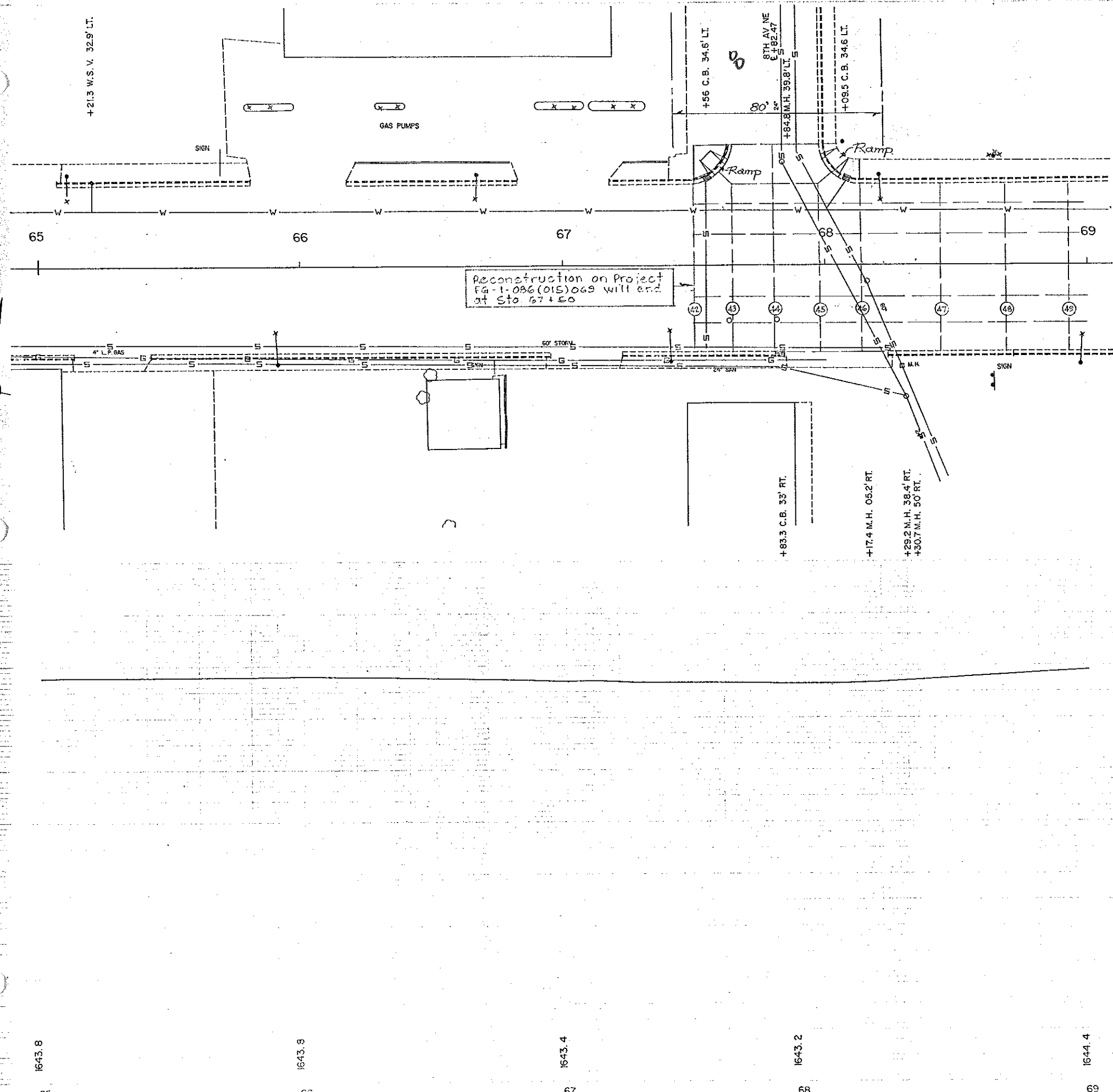

JOINT NO.	FULL DEPTH REPAIR		SPALL REPAIR		RANDOM CRACK
	DIMENSIONS	SF	DIMENSIONS	SF	
42					33
43			3 x 6, 3 x 10	49.00	
44			4 x 5	20.00	
45					
46			1.5 x 2	3.00	
* 47	8 x 6.5	52.0			
48			2 x 10	20.00	
					20
49					

* JOINT REPAIR (FULL DEPTH)

- REMOVAL OF CONCRETE
- 8TH AVE. N.E. - 45 S.Y.
- CURB & GUTTER - TYPE I
- 8TH AVE. N.E. - 45 L.F.
- SIDEWALK, CONCRETE
- 8TH AVE. N.E. - 29 S.Y.

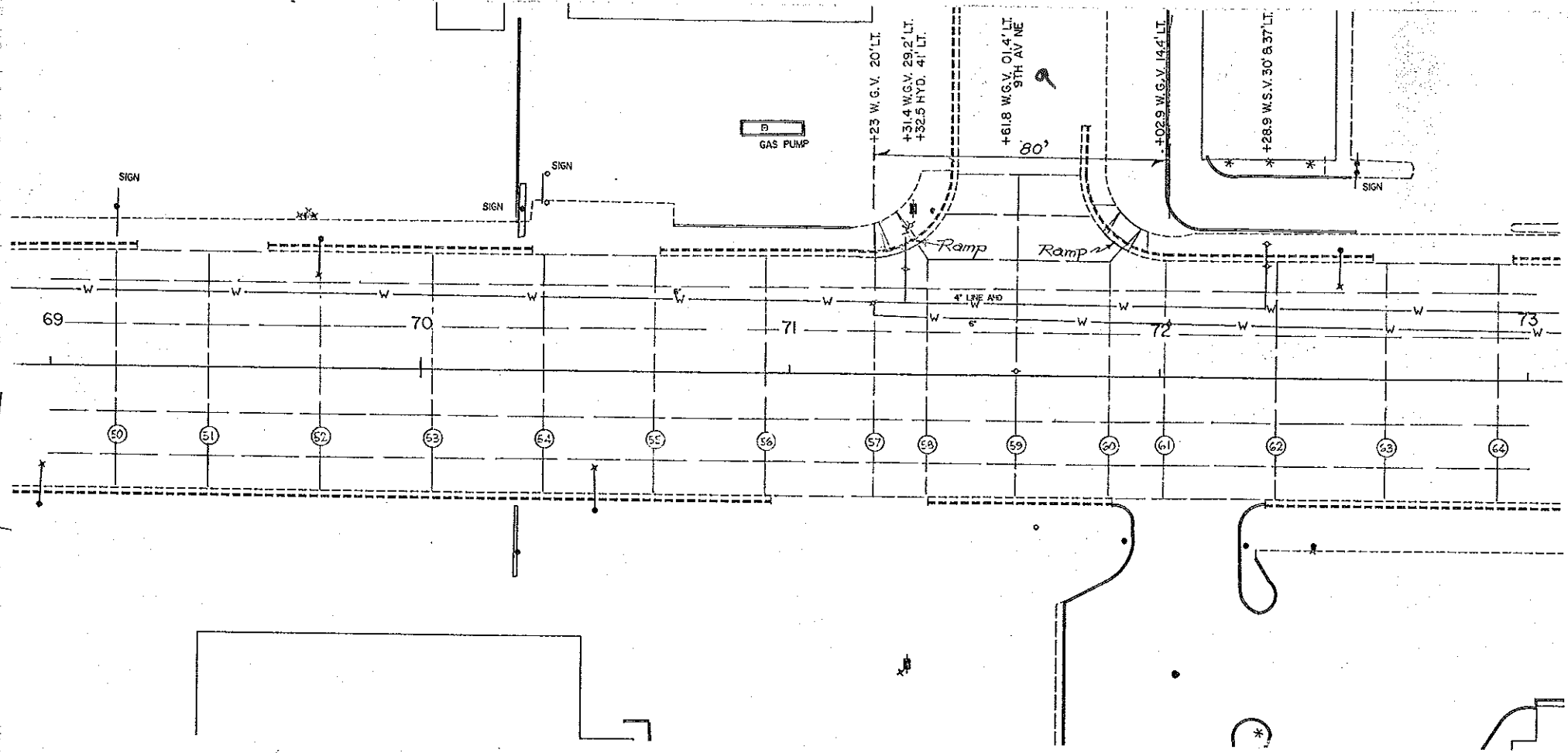

JOINT NO.	FULL DEPTH REPAIR		SPALL REPAIR		RANDOM CRACK LF
	DIMENSIONS	SF	DIMENSIONS	SF	
50			1.5 x 5, 3 x 3	16.50	
51			3 x 6	18.00	
* 52	6 x 33	198			
* 53	8 x 65	520	2 x 2, 1.5 x 3	8.50	
54			3 x 6, 1.5 x 1.5, 1.5 x 1.5	22.50	2.4
55			4 x 6, 3 x 10, 1.5 x 3, 1.5 x 2	61.50	2.4
* 56	4 x 24	96			
* 57	8 x 65	520	3 @ 1.5 x 2, 3 x 4, 2 x 3	27.00	
58			1.5 x 2, 1.5 x 1.5, 1.5 x 4, 1.5 x 2	14.25	
59			4 x 5, 2.8 x 2.3, 1.5 x 1.5, 3 x 3	43.25	
60			1.5 x 3, 3 x 8, 2 x 2, 3 x 8	43.25	15
61			2 x 4, 1.5 x 1.5	10.25	
** 62	10 x 5	50			35
* 63	4 x 24, 8 x 24	96, 192	1.5 x 1.5, 2 x 12, 1.5 x 4	32.25	
64			3 x 8, 2 x 12, 1.5 x 3	52.50	66
			2 x 2	4.00	

** CONCRETE PAVEMENT REPAIR (FULL DEPTH)
* JOINT REPAIR (FULL DEPTH)

REMOVAL OF CONCRETE
9TH AVE. N.E. - 40 S.Y.
CURB & GUTTER - TYPE I
9TH AVE. N.E. - 39 L.F.
SIDEWALK, CONCRETE
9TH AVE. N.E. - 24 S.Y.

1650
1645
1640

1650
1645
1640

1644.4
1645.8
1647.1
1648.1
1648.3

69
70
71
72
73

BENCH MARK			
NO.	LOCATION	DESCRIPTION	ELEV.
11	71 + 32.5 - 41.0 LT.	TOP OF HYDRANT	1651.10

MAIN ST MANDAN

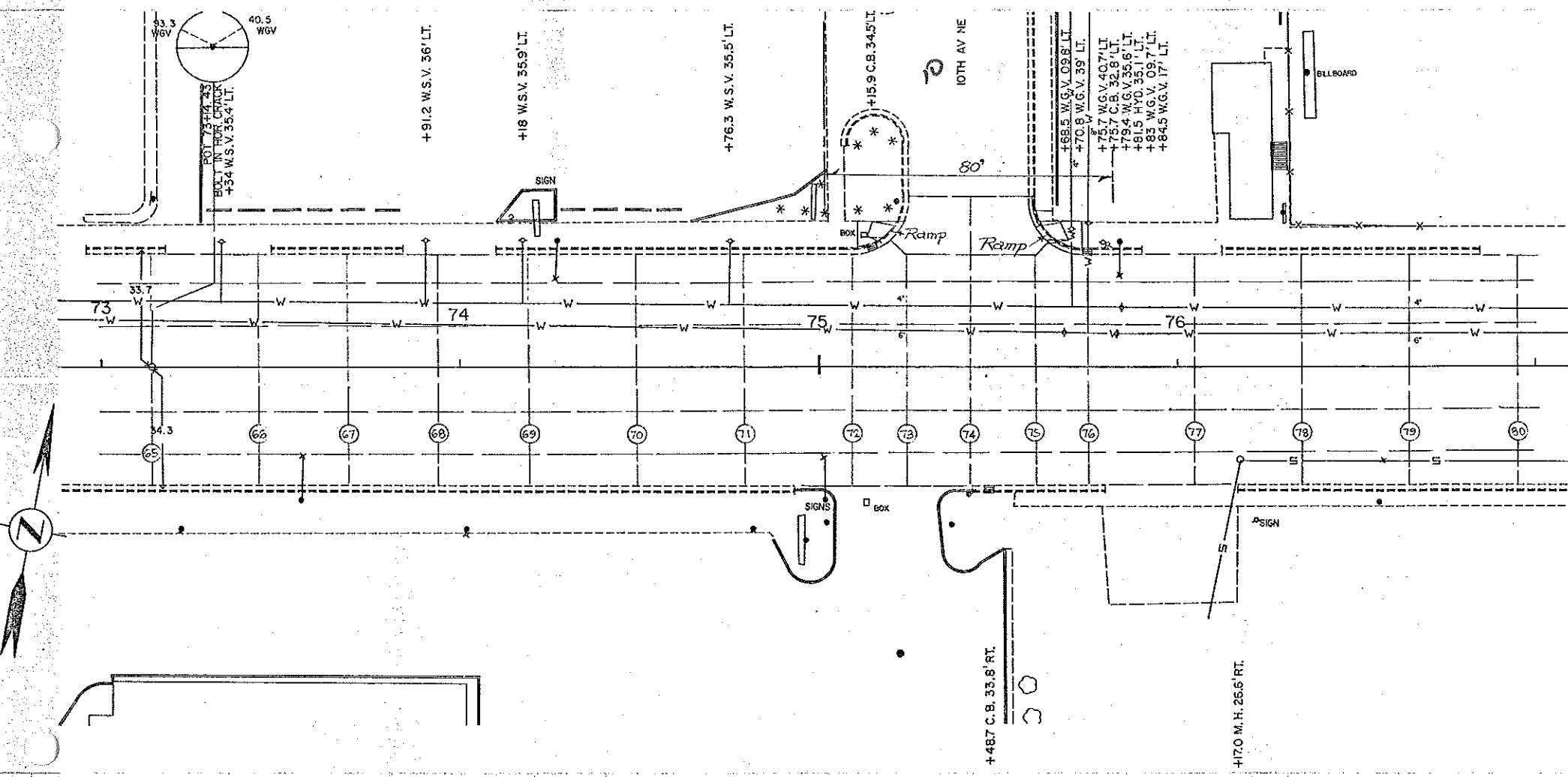

JOINT NO.	FULL DEPTH REPAIR		SPALL REPAIR		RANDOM CRACK LF
	DIMENSIONS	SF	DIMENSIONS	SF	
65			2' x 2', 1.5' x 1'	7.00	12
66					17
67					
**	6' x 24', 6' x 12'	216			
**	12' x 24'	288			
68			1.5' x 1.5'	2.25	
69			2' x 4', 2' x 2'	12.00	48
					36
70			1.5' x 1.5', 1.5' x 2'	9.75	
*	9' x 33'	297			
*	6' x 33'	198			
71					
*	6' x 24'	144			
*	8' x 24'	192			
72			1.5' x 2'	3.00	
73			1.5' x 2', 1.5' x 4'	9.00	
74					
75					
76			1.5' x 3', 3' x 24'	76.50	
**	6' x 30'	180			
**	15' x 24'	360			
77					
*	7' x 66'	462			
78			1.5' x 1.5'	2.25	
					24
79			1.5' x 1.5', 3' x 4', 1.5' x 6'	23.25	
*	6' x 33'	198			
*	8' x 33'	264			
80			2' x 3', 1.5' x 3'	10.50	
*	5' x 33'	165			33

* JOINT REPAIR (FULL DEPTH) 1650
 ** CONC. PVT. REPAIR (FULL DEPTH) 1650

REMOVAL OF CONCRETE
 10TH AVE. N.E. - 18.57 1645

CURB & GUTTER TYPE I
 10TH AVE. N.E. - 351.7 1640

SIDEWALK, CONCRETE
 10TH AVE. N.E. - 17.57 1640

1650
 1645
 1640

BENCH MARK			
NO.	LOCATION	DESCRIPTION	ELEV.
12	75 + 81.5 - 35.1' LT.	TOP OF HYDRANT	1649.61

1648.3 73
 1647.6 74
 1646.9 75
 1646.1 76
 1645.3 77

MAIN ST MANDAN

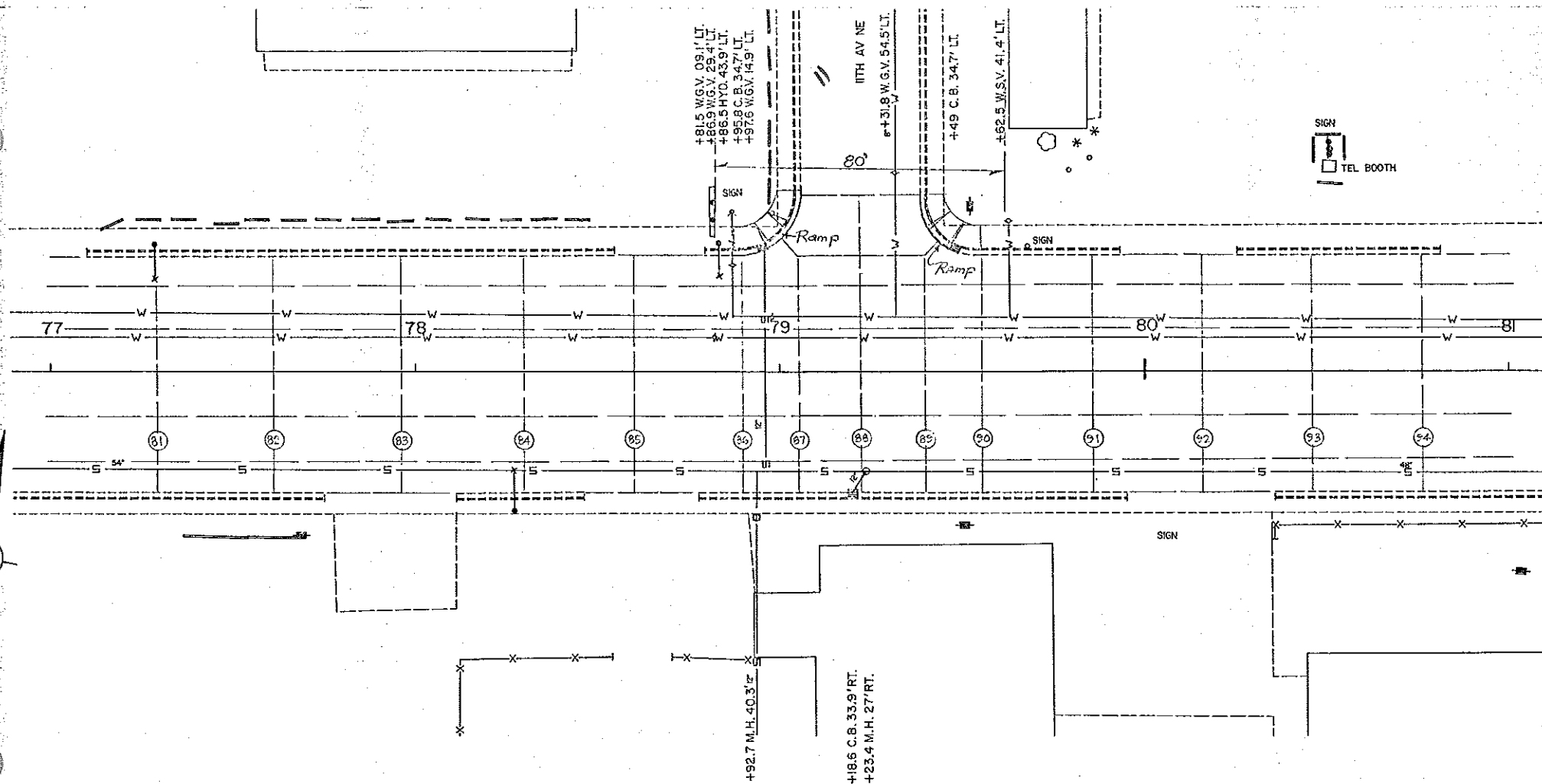

JOINT NO.	FULL DEPTH REPAIR		SPALL REPAIR		RANDOM CRACK
	DIMENSIONS	SF	DIMENSIONS	SF	
81			2 x 6, 1.5 x 3	16.50	
82			4 x 17, 3 x 15	113.00	
83					14
* 84	4 x 12	48			33 16
* 85	8 x 65	520	3 x 12, 2 x 2, 1.5 x 12	58.00	
* 86	6 x 24	144	3 x 10, 1.5 x 1.5	32.25	20
87			2 x 5	10.00	
88			2 x 4, 2 x 3	14.00	
89			2 x 15	30.00	
** 90	12 x 12	144			
** 91	12 x 14 6 x 65	168 390			
** 92			2 x 15	30.00	66
** 93	30 x 24 6 x 24	720 144	2 x 15	30.00	
94					24
95			2 x 14	28.00	

* JOINT REPAIR (FULL DEPTH)
 ** CONC. PMT. REPAIR (FULL DEPTH)

REMOVAL OF CONCRETE
 11TH AVE. N.E. - 27 S.F.

CURB & GUTTER TYPE I
 11TH AVE. N.E. - 50 L.F.

SIDEWALK, CONCRETE
 11TH AVE. N.E. - 33 S.F.

1650
 1645
 1640

1650
 1645
 1640

1645.3
 77

1644.7
 78

1644.3
 79

1643.8
 80

1643.2
 81

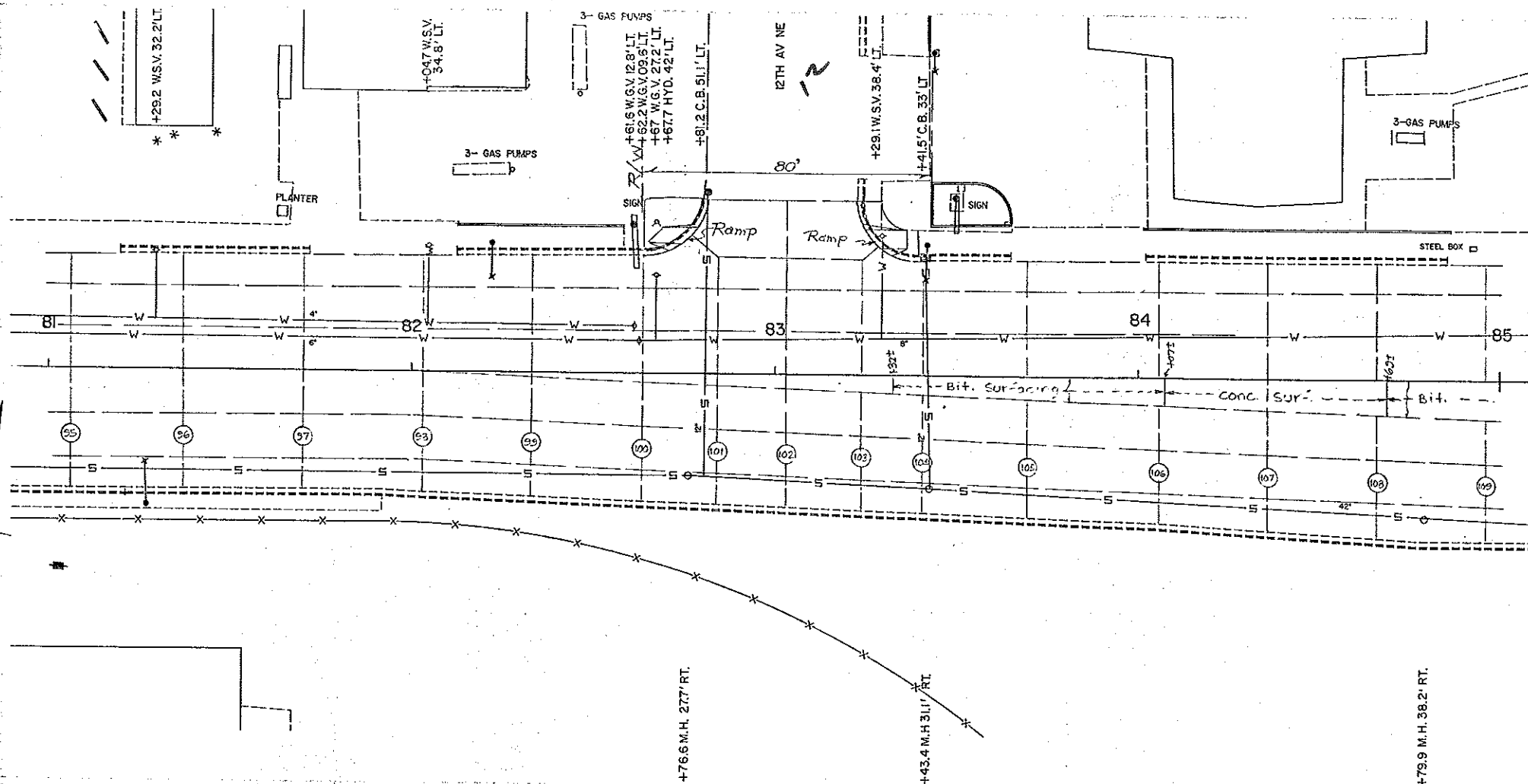

JOINT	FULL DEPTH REPAIR		SPALL REPAIR		RANDOM CRACK
	DIMENSIONS	SF	DIMENSIONS	SF	
96			2 x 24	49.00	
* 97	8 x 65	520			
98	4 x 14 8 x 12	56	2 x 3, 2 x 10	26.00	
* 99	6 x 33	198	1.5 x 2	3.00	12
**	30 x 24 4 x 12	720 48	2 x 3, 1.5 x 1.5, 1.5 x 3, 1.5 x 2	17.25	33
100					
101			2 x 6, 1.5 x 1.5, 1.5 x 2, 4 x 6	53.25	
102			1.5 x 3, 2 x 6, 2 x 3	22.50	
103			1.5 x 2	3.00	
* 104	8 x 33	264			
105			6 x 8, 6 x 24, 2 x 12	216.00	
**	10 x 30 15 x 24	300 360	2 x 2, 1.5 x 2, 4 x 4, 1.5 x 3, 1.5 x 2	30.50	20
106					
* 107	6 x 74	444			
108			2 x 6 1.5 x 1.5	14.25	24
* 109	4 x 22	88			24
110			2 x 5, 1.5 x 4	16.00	

* * ADDITIONAL FULL DEPTH REPAIRS (SEE SECTION & NOTE BELOW LEFT)
 83+32± TO 84+07± RT. - 488 S.F.
 84+07± TO 85+00 RT. - 326 S.F.

* JOINT REPAIR (FULL DEPTH)
 ** CONC. PVMT. REPAIR (FULL DEPTH)

REMOVAL OF CONCRETE
 12TH AVE. N.E. - 23 S.F.

CURB & GUTTER TYPE-I
 12TH AVE. N.E. - 47 L.F.

SIDEWALK, CONCRETE
 12TH AVE. N.E. - 40 S.F.

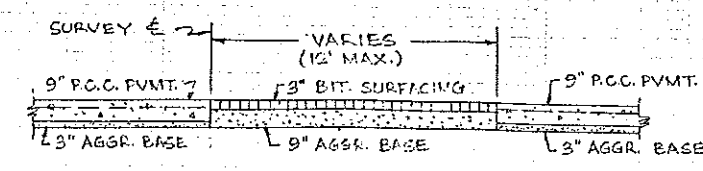

EXISTING MERIAN SECTION
 83+32± TO 84+07±
 84+09± TO 85+29±
 87+11± TO 87+56±

Reconstruction of the areas listed above shall be in accordance with the details and specifications for full depth pavement repair. See Note 200-P24 for subcutting and backfilling.

BENCH MARK			
NO.	LOCATION	DESCRIPTION	ELEV.
13	82+67.7 - 42.0' LT.	TOP OF HYCRANT	1644.35

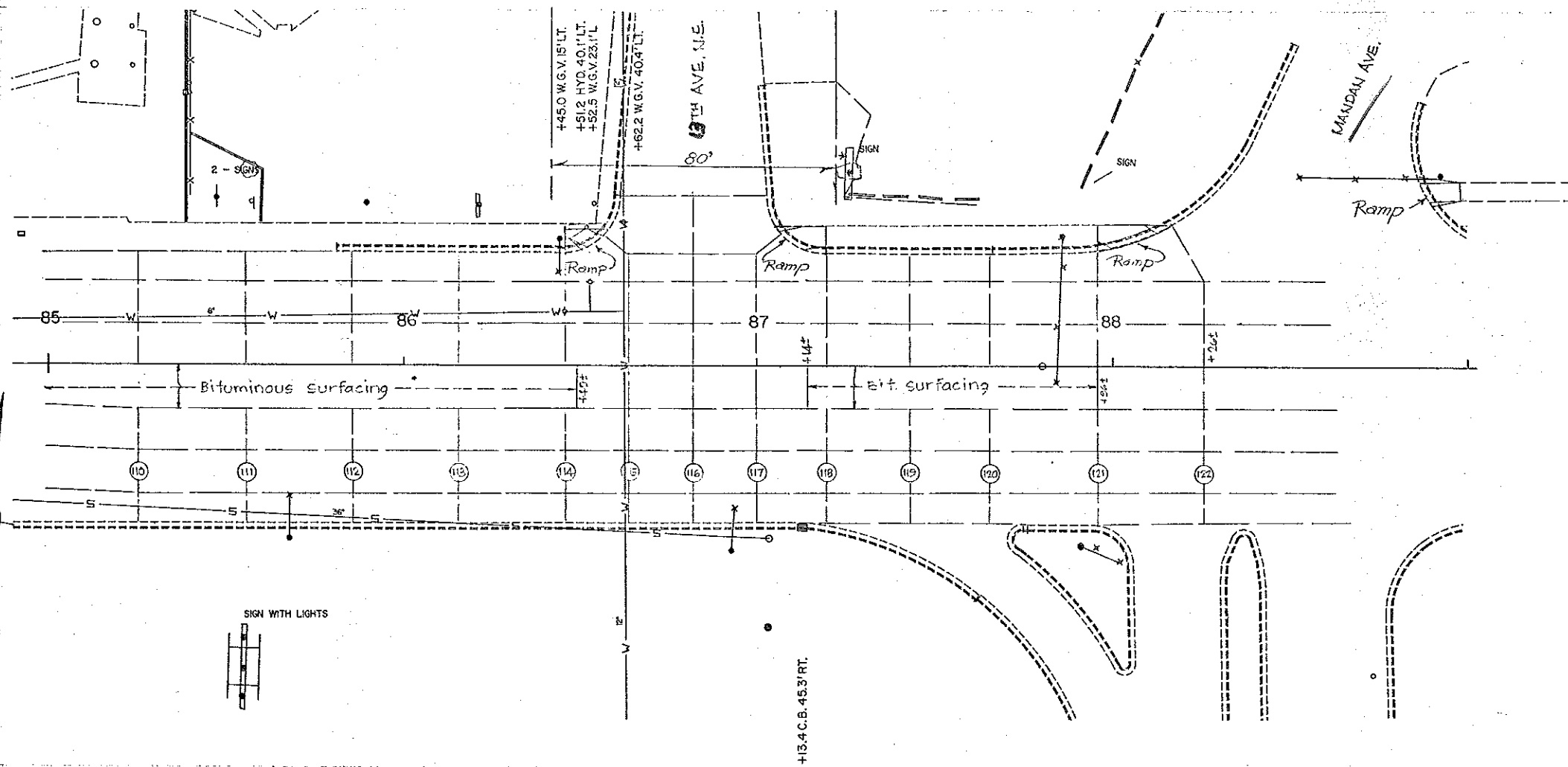

JOINT NO.	FULL DEPTH REPAIR		SPALL REPAIR		RANDOM CRACK LF
	DIMENSIONS	SF	DIMENSIONS	SF	
					32
110			1.5 x 3, 2 x 4	12.50	
* 111	4 x 32	128	2 x 3, 2 x 3, 2 x 3	21.00	
** 112	4 x 12 17 x 12	48 204	2 x 4	8.00	
** 113	4 x 12 15 x 12	48 180	3 x 3, 2 x 3	18.00	2.4
114			3 x 12	36.00	
115					
116					
117			2 x 20	40.00	
118			3 x 4, 3 x 3, 1.5 x 6, 1.5 x 12	48.00	2.4
119					2.4
120			2 x 12, 2 x 4	52.00	
* 121	6 x 24 5 x 38	144 190	3 x 9, 2 x 3, 1.5 x 2, 2 x 2, 2 x 4, 1.5 x 1.5	50.25	2.4
* 122	4 x 24	96	2 x 12, 2 x 4	52.00	

* * ADDITIONAL FULL DEPTH REPAIRS (SEE DETAIL ON PREVIOUS SHEET)
85+00 TO 86+49± RT. - 2776 S.F.
87+14± TO 87+96± RT. - 984 S.F.

* JOINT REPAIR (FULL DEPTH)
* * CONC. PVMT. REPAIR (FULL DEPTH)

REMOVAL OF CONCRETE
13TH AVE. N.E. - 16 S.Y.
MANDAN AVE. - 15 S.Y.
CURB & GUTTER TYPE-I
13TH AVE. N.E. - 30 L.F.
MANDAN AVE. - 30 L.F.
SIDEWALK, CONCRETE
13TH AVE. N.E. - 15 S.Y.
MANDAN AVE. - 9 S.Y.

BENCH MARK			
NO.	LOCATION	DESCRIPTION	ELEV.
14	86+51.2 - 40.4' LT.	TOP OF HYDRANT	1640.78

FHWA REGION	STATE	FED. AID PROJ. NO.	SHEET NO.
8	N.D.	F-1-094(006) 915	

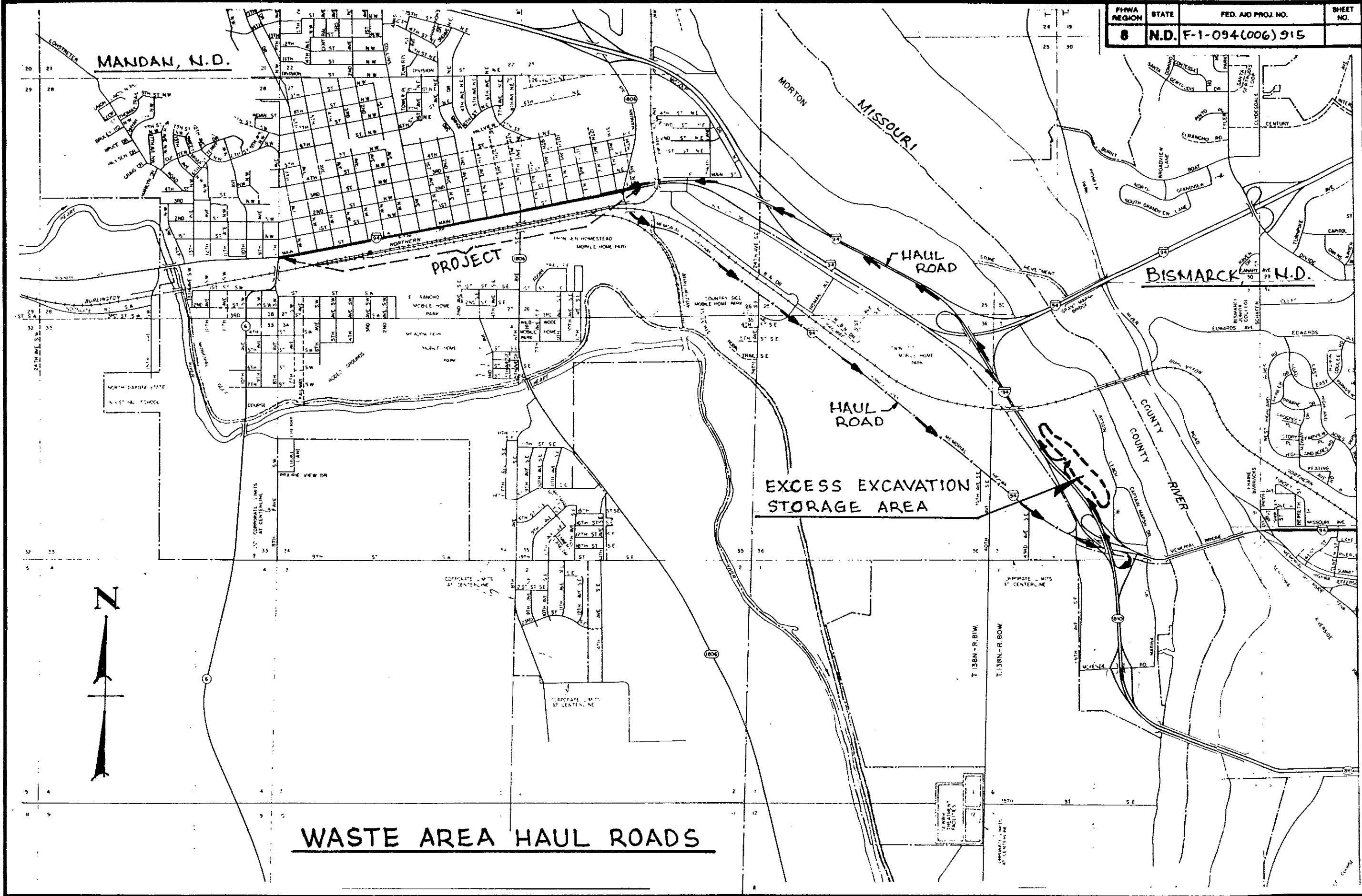

WASTE AREA HAUL ROADS

PAVEMENT LAYOUT DETAILS

FHWA REGION	STATE	FED. AID PROJ. NO.	SHEET NO.
8	N.D.	F-1-094(006) 915	

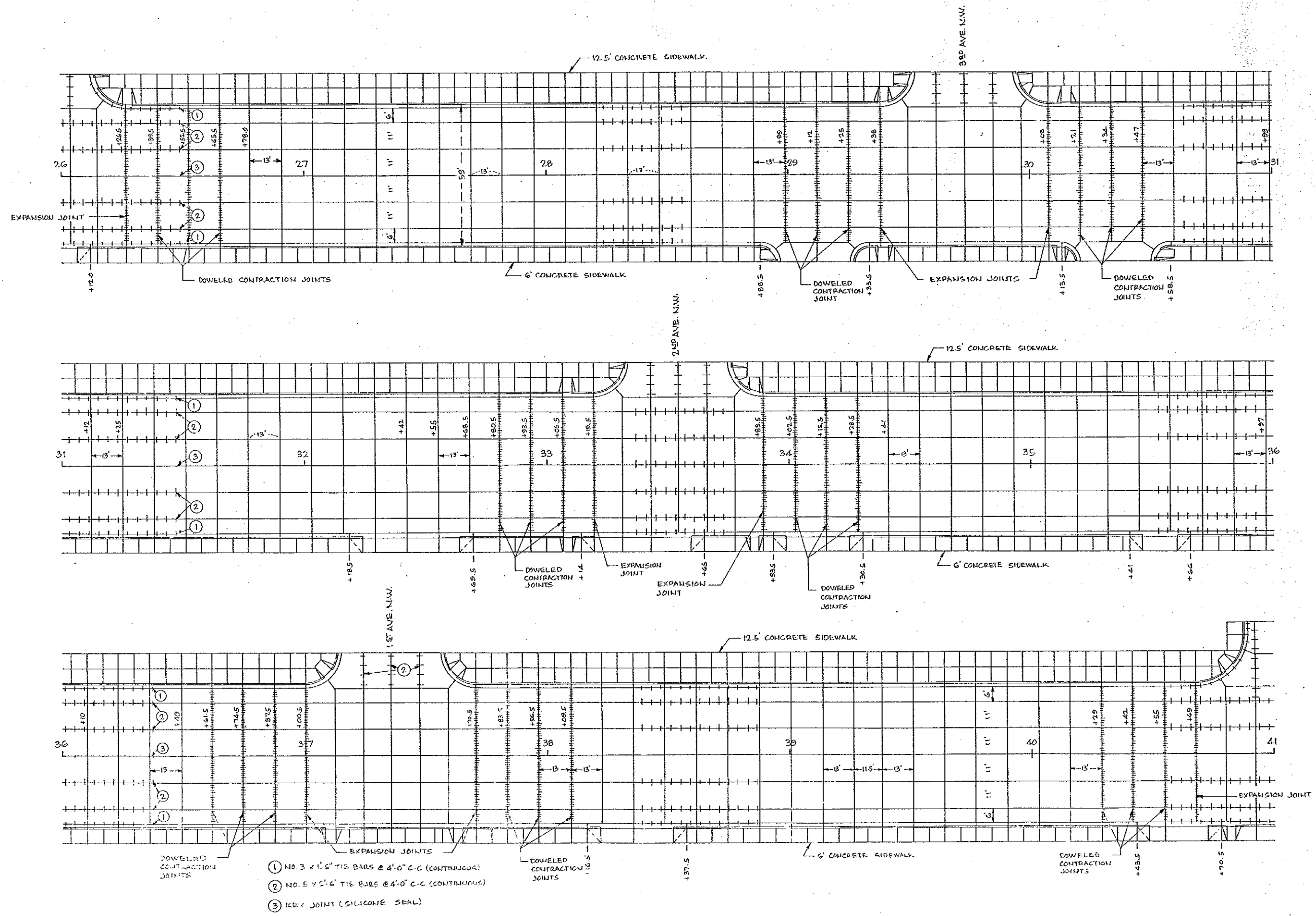

- ① NO. 3 x 1.6" TIE BARS @ 4'-0" C-C (CONTINUOUS)
- ② NO. 5 x 2'-6" TIE BARS @ 4'-0" C-C (CONTINUOUS)
- ③ KEY JOINT (SILICONE SEAL)

PAVEMENT LAYOUT DETAILS

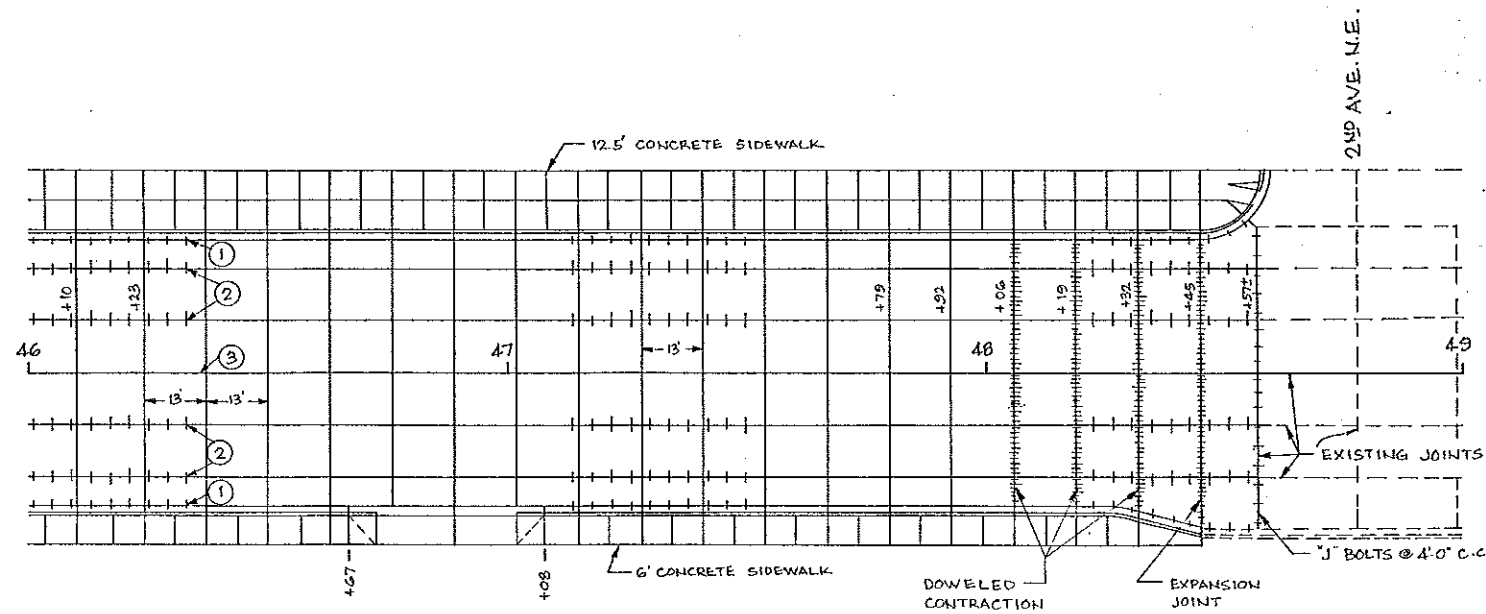
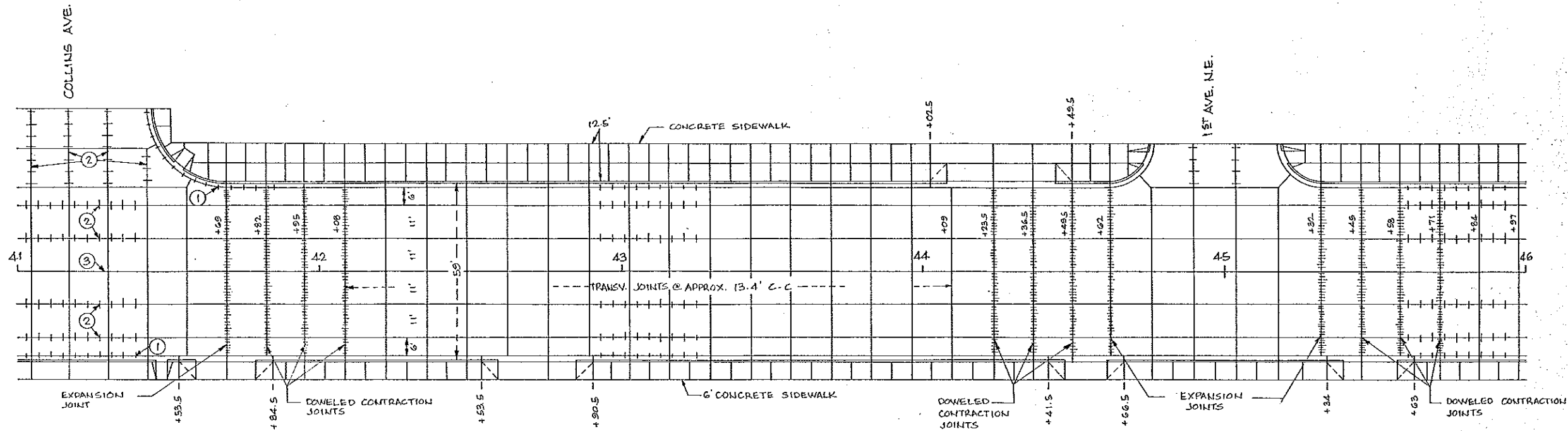

- ① NO. 3 x 1'-6" TIE BARS @ 4'-0" C-C (CONTINUOUS)
- ② NO. 5 x 2'-6" TIE BARS @ 4'-0" C-C (CONTINUOUS)
- ③ KEYED JOINT (SILICONE SEAL)

JOINT DETAILS
STA. 11+00 TO 48+57

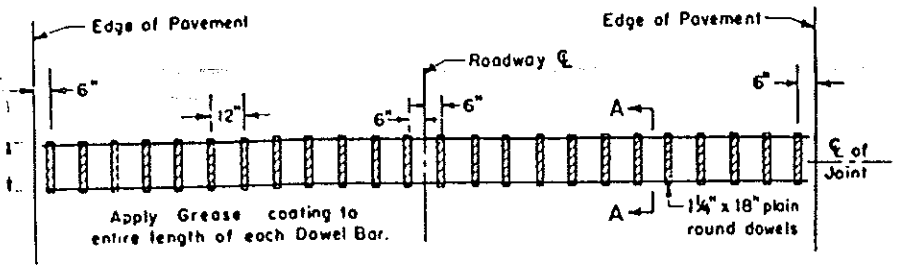

PLAN
CONTRACTION JOINT DOWEL BAR ASSEMBLY

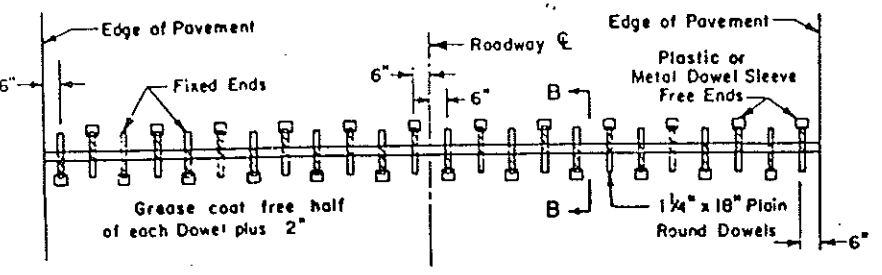

PLAN
EXPANSION JOINT DOWEL BAR ASSEMBLY

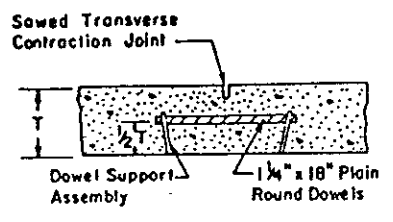

SECTION A-A

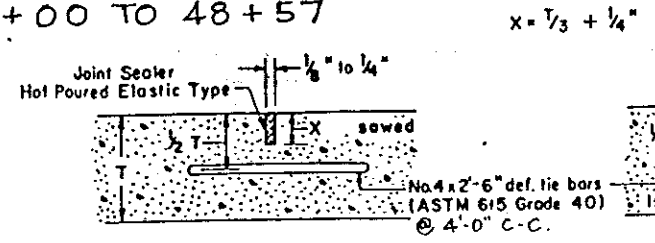

SAWED LONGITUDINAL JOINT
(FOR ALL TIED LONGITUDINAL JOINTS)

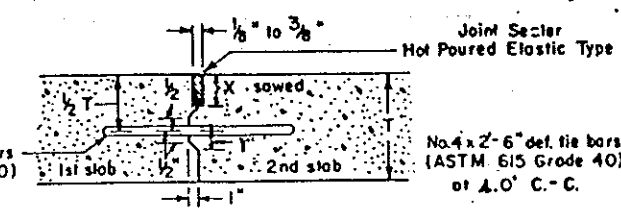

LONGITUDINAL CONSTRUCTION JOINT
(KEYED TIED JOINT)

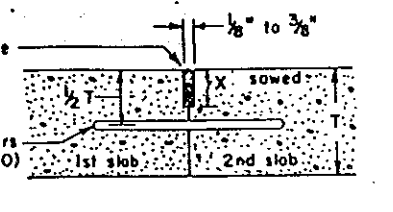

LONGITUDINAL CONSTRUCTION JOINT
(TIED BUTT JOINT)

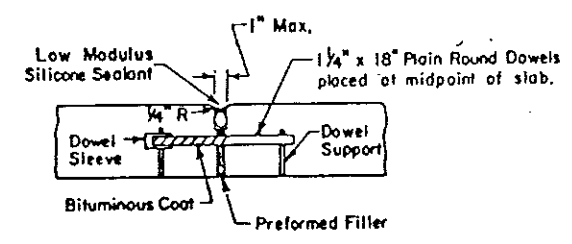

SECTION B-B

PREFORMED COMPRESSION JOINT SEAL FOR TRANSVERSE CONTRACTION JOINTS
(FOR ALL TRANSVERSE CONTRACTION JOINTS)

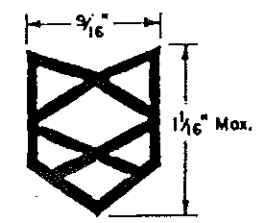

Seal to be installed 1/8\"/>

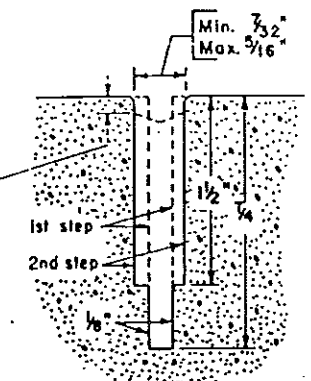

SAWED TRANSVERSE JOINT

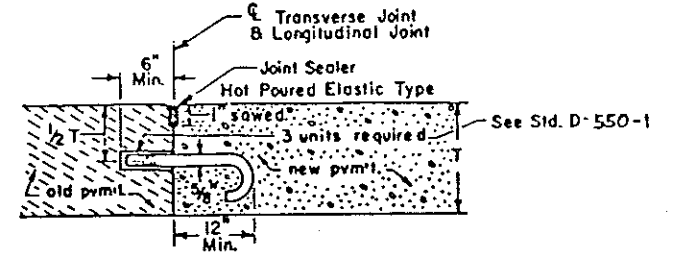

J-BOLT INSTALLATION
(MAX. SPACING OF 4.0' C.-C. WHERE NEW CONCRETE ABUTS EXISTING CONC.)

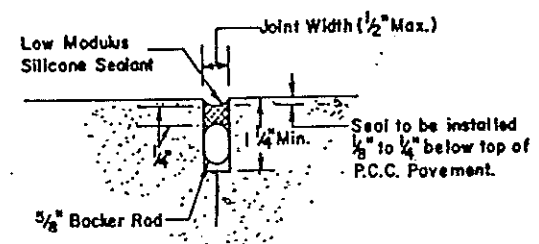

LONGITUDINAL JOINT SILICONE SEAL
(FOR CENTERLINE JOINT ONLY)

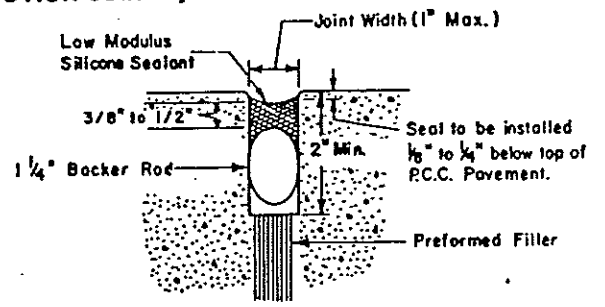

INSTALLATION
(EXPANSION JOINT SILICONE SEAL)
(FOR EXPANSION JOINTS ONLY)

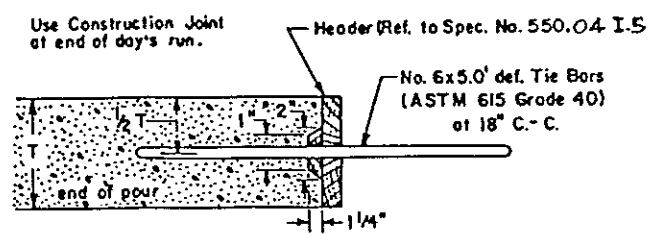

TRANSVERSE CONSTRUCTION JOINT
(KEYED & TIED JOINT)

NOTE:
Construction Joints to be sawed to a depth of 1\"/>

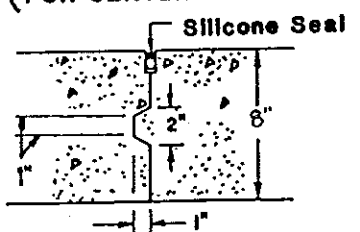

LONGITUDINAL KEYPED JOINT
(CENTERLINE JOINT ONLY)

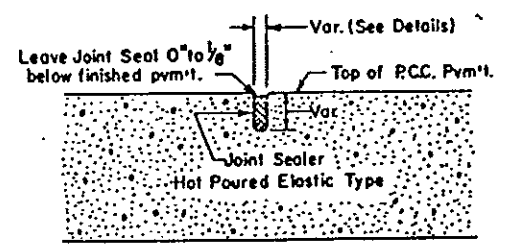

JOINT SEALER DETAIL
(APPLIES TO ALL SAWED JOINTS EXCEPT AS SHOWN)

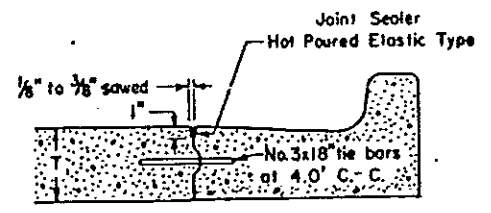

JOINT SEALER AT ALL CURB & GUTTER SECTIONS

NOTE:
Preformed inserts used to form grooves for transverse joints will not be allowed.
Preformed compression joint seals of other shapes may be used. The shape and dimensions must be approved by the Engineer.

EXISTING JOINTS AND
JOINT SAWING DETAILS
STA. 48+57 TO 88+26±

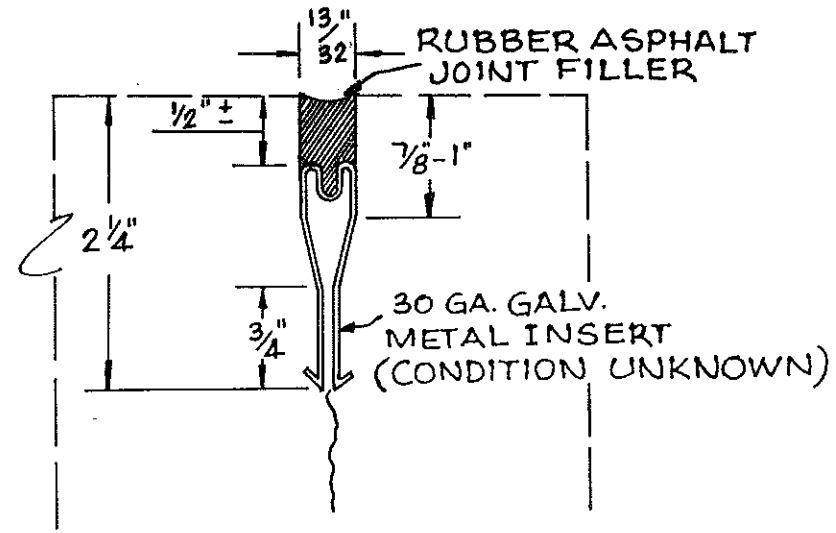

EXISTING TRANSVERSE JOINT

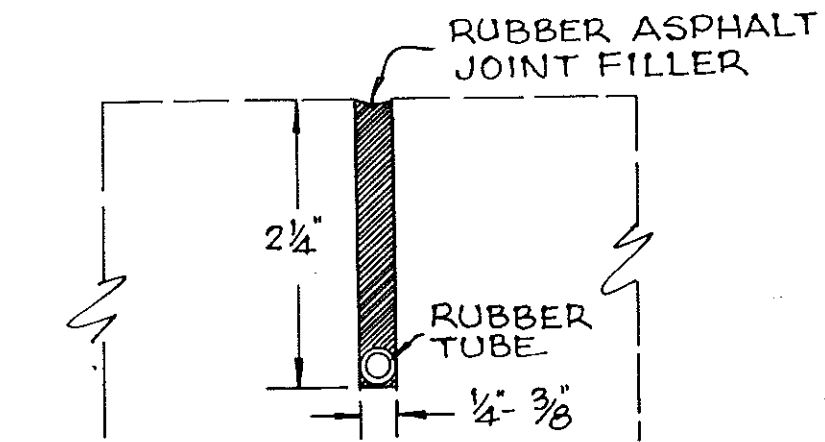

EXISTING LONGITUDINAL JOINT

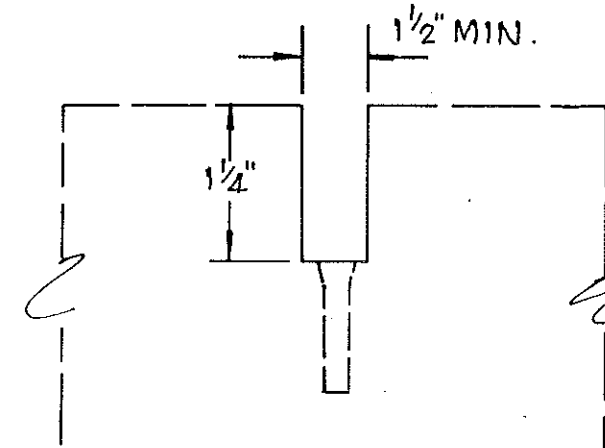

SAWING DETAILS
EXISTING TRANSVERES JOINT

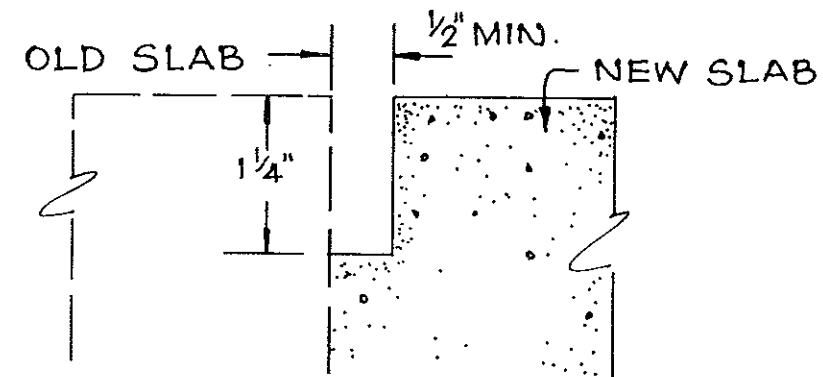

SAWING DETAIL
TRANSVERES JOINTS
AT FULL DEPTH REPAIRS

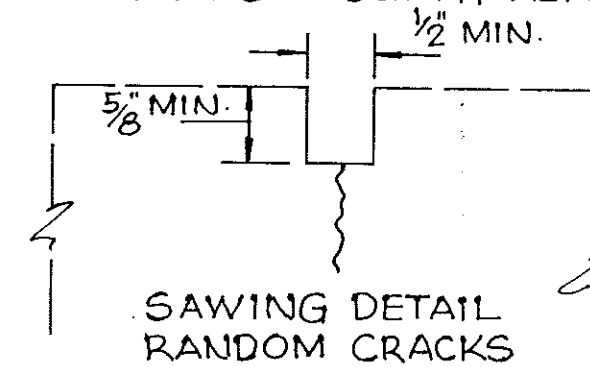

SAWING DETAIL
RANDOM CRACKS

JOINT SEALING DETAILS
STA. 48+57 TO 88+26±

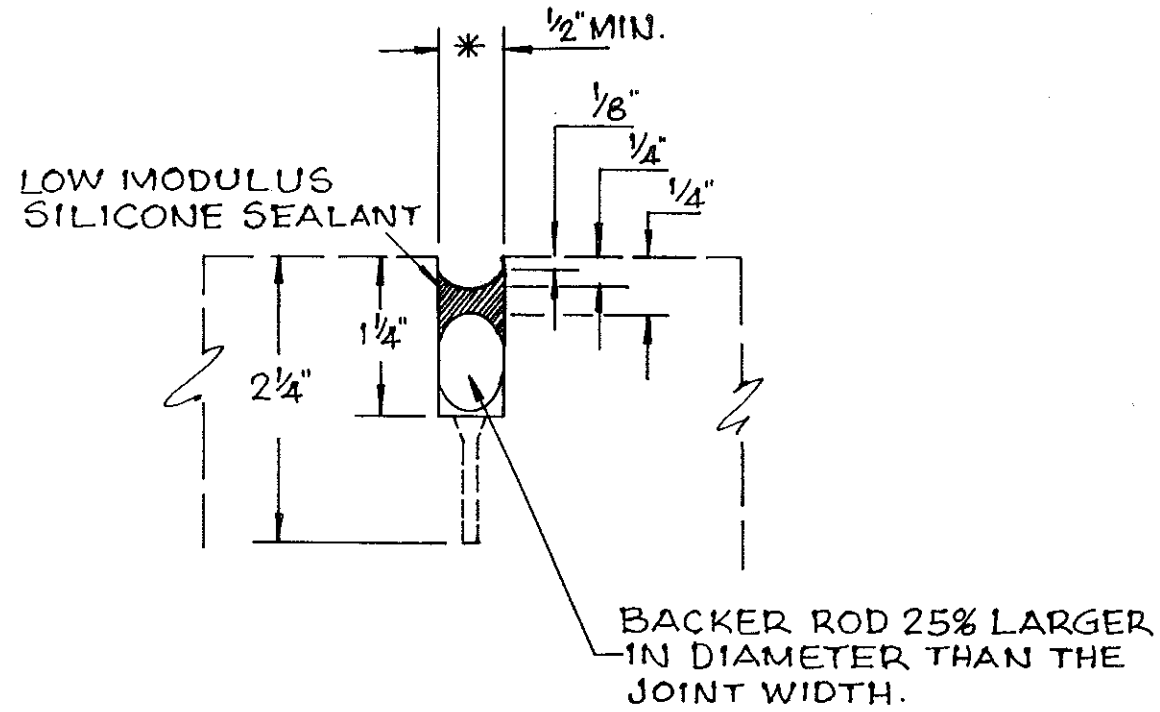

TRANSVERSE JOINTS
(INCLUDES JOINTS AT FULL DEPTH REPAIRS)

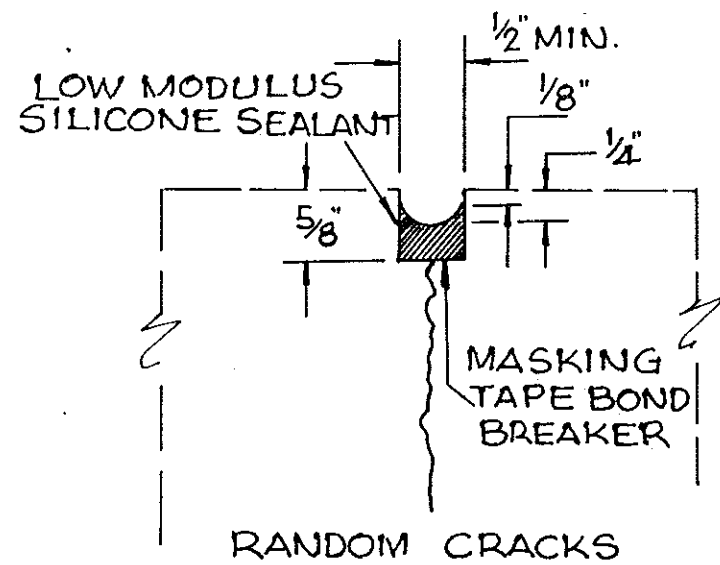
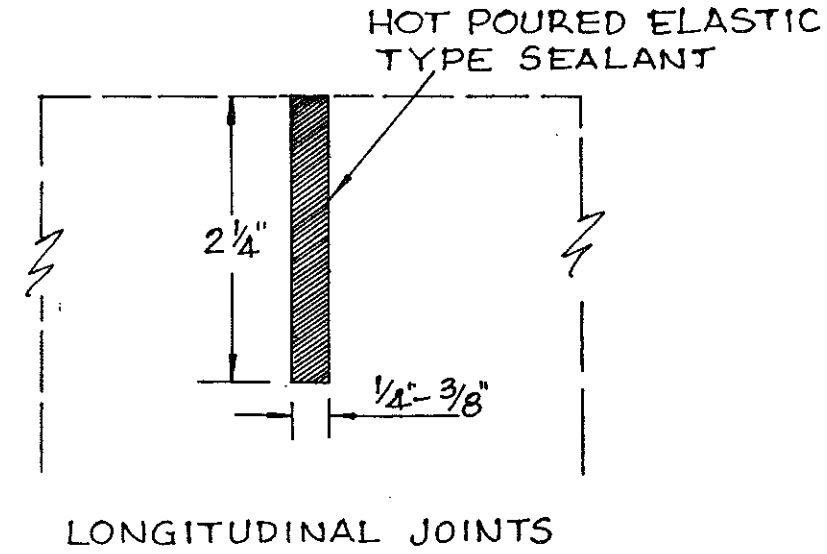

TRANSVERSE JOINTS

* IF EXISTING JOINT SIZE IS GREATER THAN 1/2" MAINTAIN WIDTH TO DEPTH FACTOR. ON EXISTING JOINTS HAVING A JOINT WIDTH GREATER THAN 1/2", THE ACTUAL DEPTH SHALL BE DETERMINED IN THE FIELD AND SHALL BE AS PER THE MANUFACTURERS RECOMMENDATIONS.

PWMA REGION	STATE	FED. AID PROJ. NO.	SHEET NO.
6	N.D.	F-1-094(006) 915	

CONCRETE PAVEMENT REPAIR (FULL DEPTH)
(Longitudinal Length more than 8' feet)

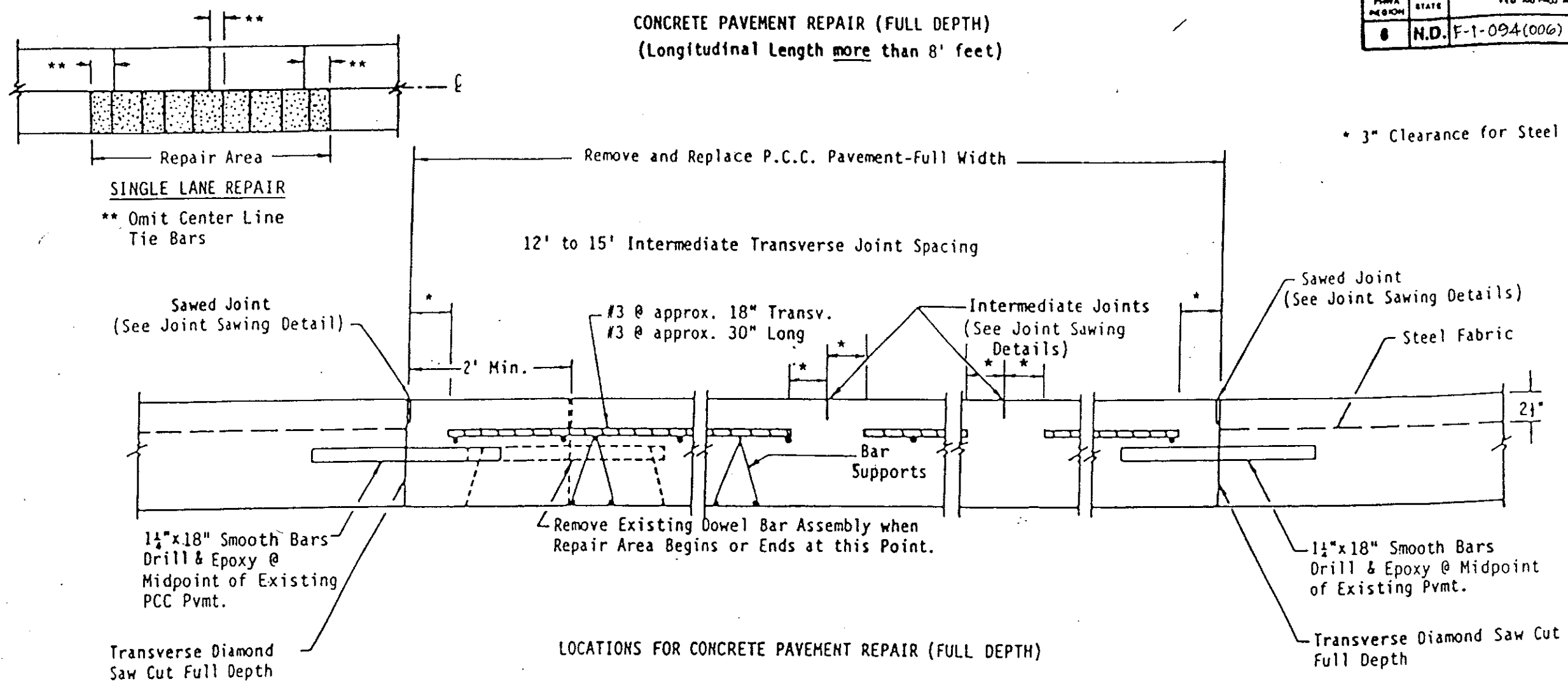

FHWA REGION	STATE	FED. AID PROJ. NO.	SHEET NO.
6	N.D.	F-1-094(006) 915	

JOINT REPAIR (FULL DEPTH)
(Longitudinal length 8' or less)

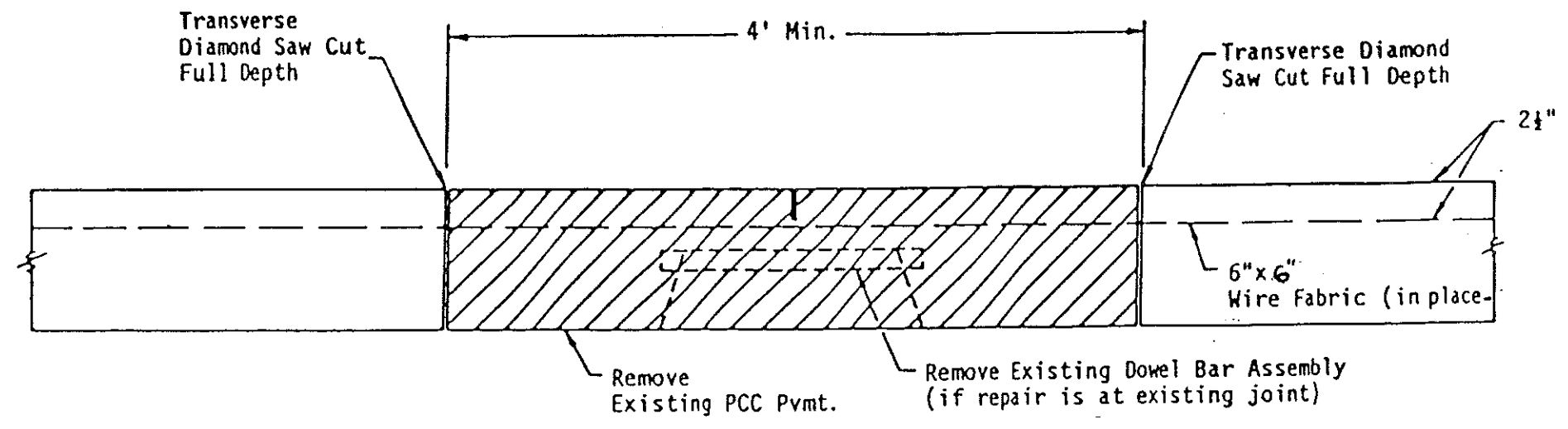

FULL DEPTH PVMT. REMOVAL

NOTE: Removal and Replacement also applies to full depth repair at random cracks.

NOTE: * 3" Clearance for Steel (repair perimeter)

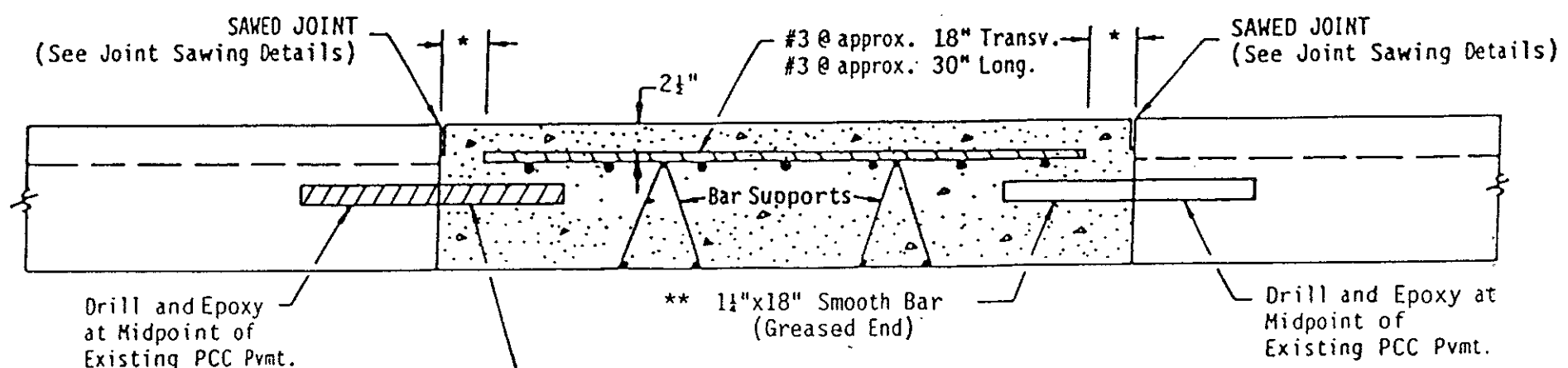

FULL DEPTH PVMT. REPLACEMENT

Note:
See Joint and Spall Repair Location Sheets for locations of repairs of 8' or less in longitudinal length.

**Place smooth dowel bars in repair joint which is farthest away from next transverse joint or working random crack. If distance is equal for both repair joints, place smooth dowels on approach side of patch.

AREA REGION	STATE	FED. AID PROJ. NO.	SHEET NO.
8	N.D.	F-1-094(006)915	

Dowel & Grout Installation

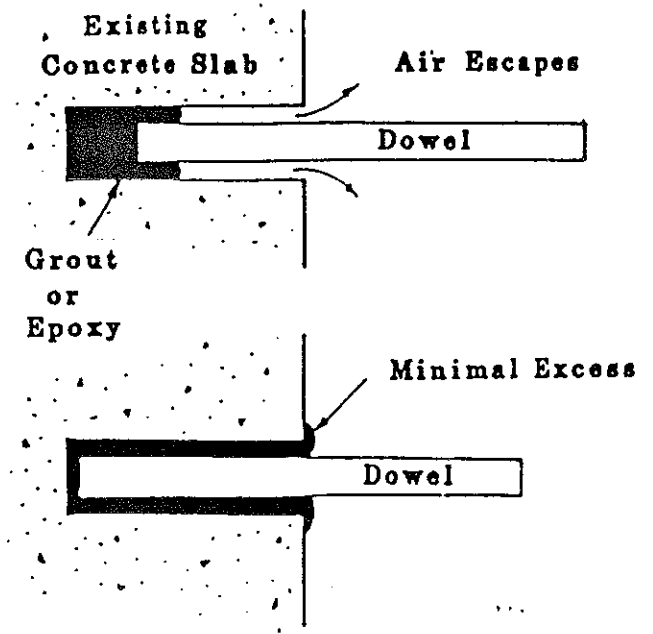

DOWEL BAR PLACEMENT - FULL DEPTH REPAIRS
(Smooth or Deformed Bars)

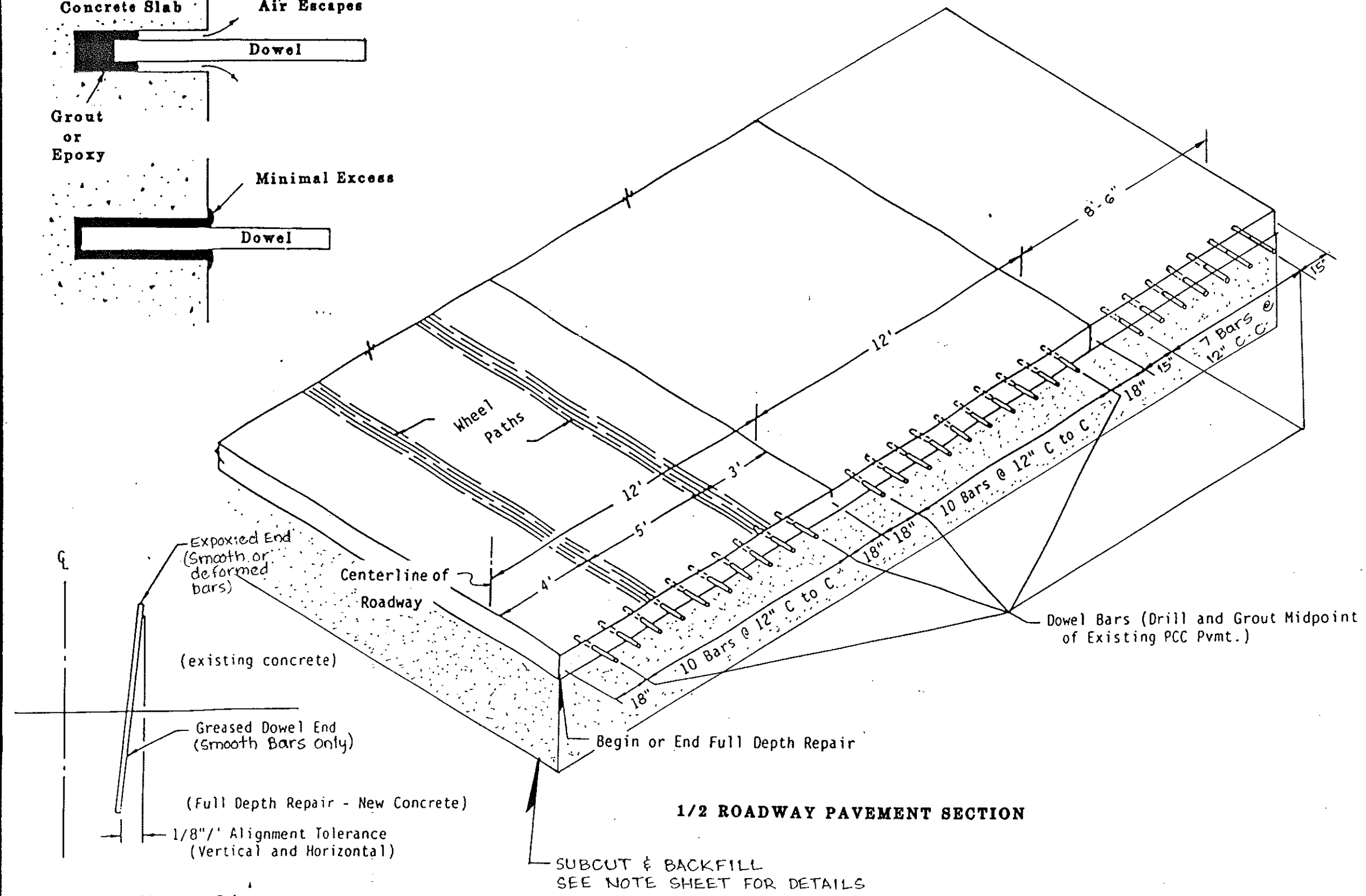

Dowel Alignment Tolerances
(Smooth Bars)

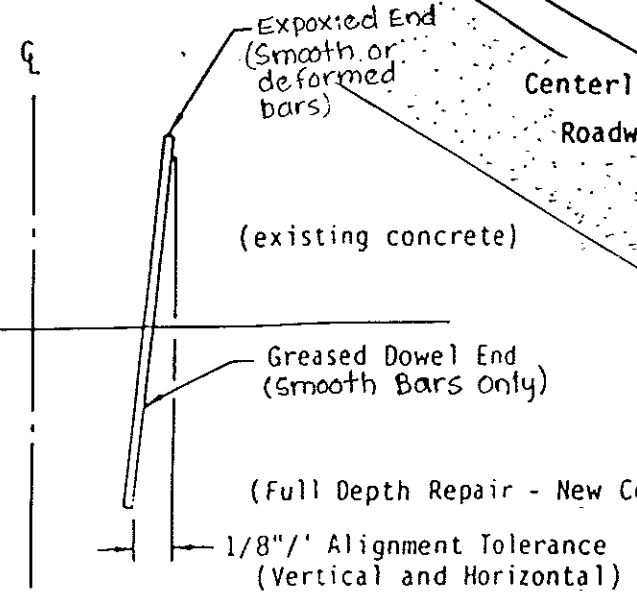

SPALL REPAIR DETAILS

FHWA REGION	STATE	FED. AID PROJ. NO.	SHEET NO.
8	N.D.	F-1-094(006)915	

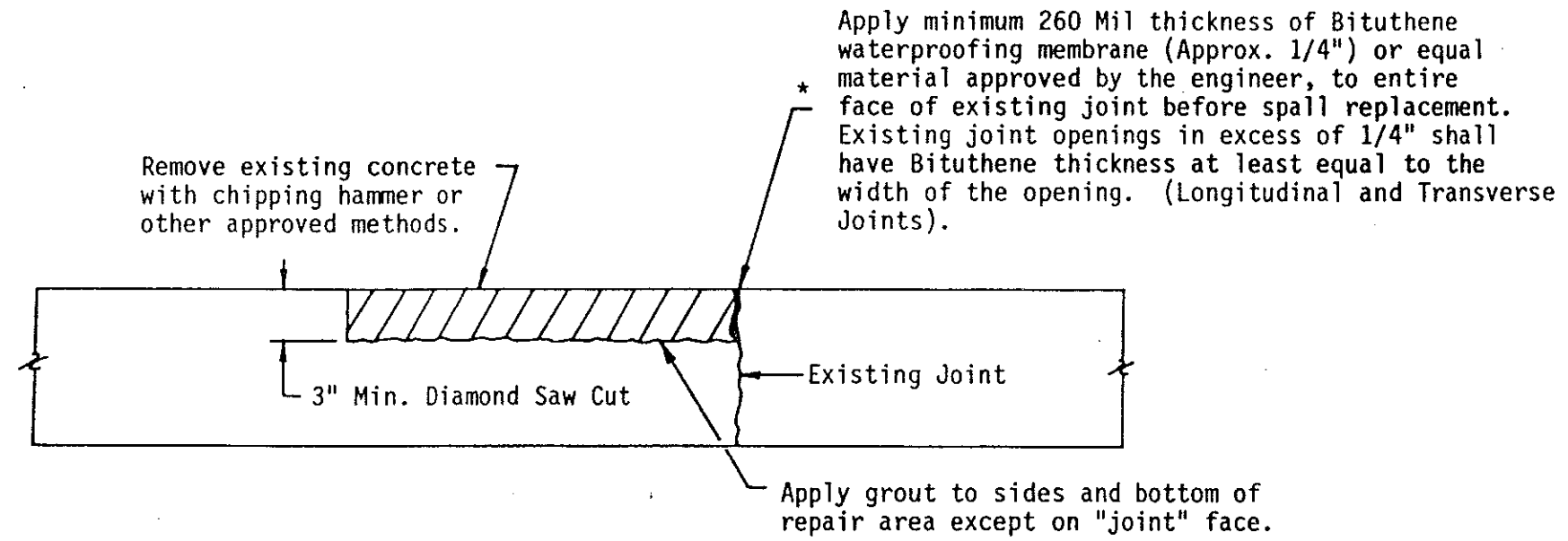

CROSS SECTION

*The membrane material shall be field cut to fit over the entire face of the existing joint. The material shall be placed so as to provide for expansion and to prevent water from entering the existing joint on either sides or the bottom. The material shall be hand pressed into place to conform to the face of the existing joint.

If spall repair is required on direct opposite locations, the membrane material shall be installed directly over the existing crack. The material shall be placed one patch at a time with adequate time provided for curing. A support such as a removable backing board shall be used. The material shall be placed so as to provide the same expansion action as provided by the one sided repair application.

The purpose of the membrane material is to prevent point contact with the adjacent slab which would put undue pressure on the spall repair causing failure. No substitutes such as sawing or a rigid preformed joint material will be allowed because of their inability to either cover the entire face of the joint or because it cannot conform to the portion of the joint face which cracked after the original sawing operation.

FHWA REGION	STATE	FED. AID PROJ. NO.	SHEET NO.
8	N.D.	F-1-094(006) 915	

METHOD OF MAINTAINING JOINTS AT SPALL REPAIRS

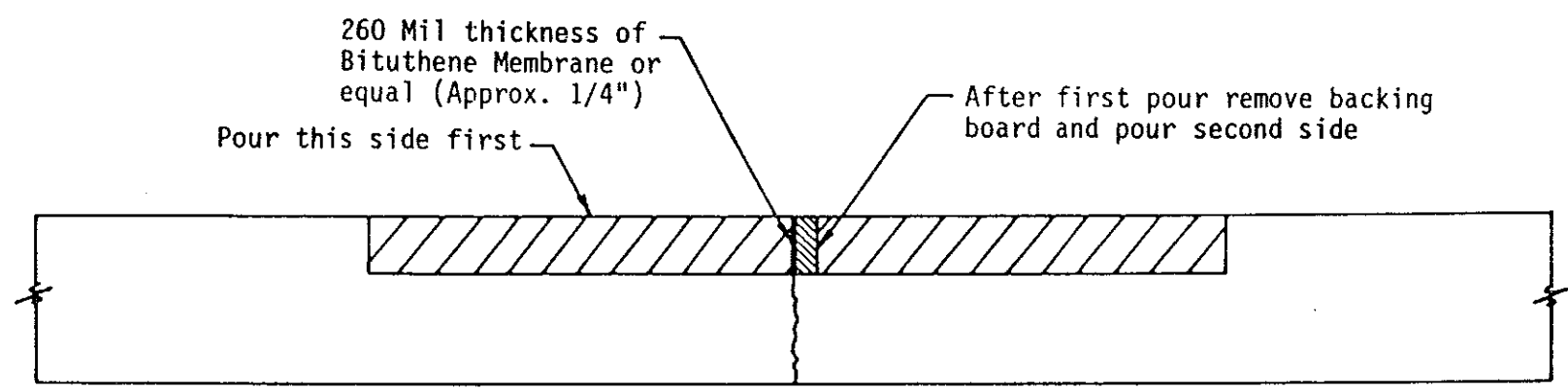

SIDE VIEW

View of repair at location where spall repairs are directly opposite.

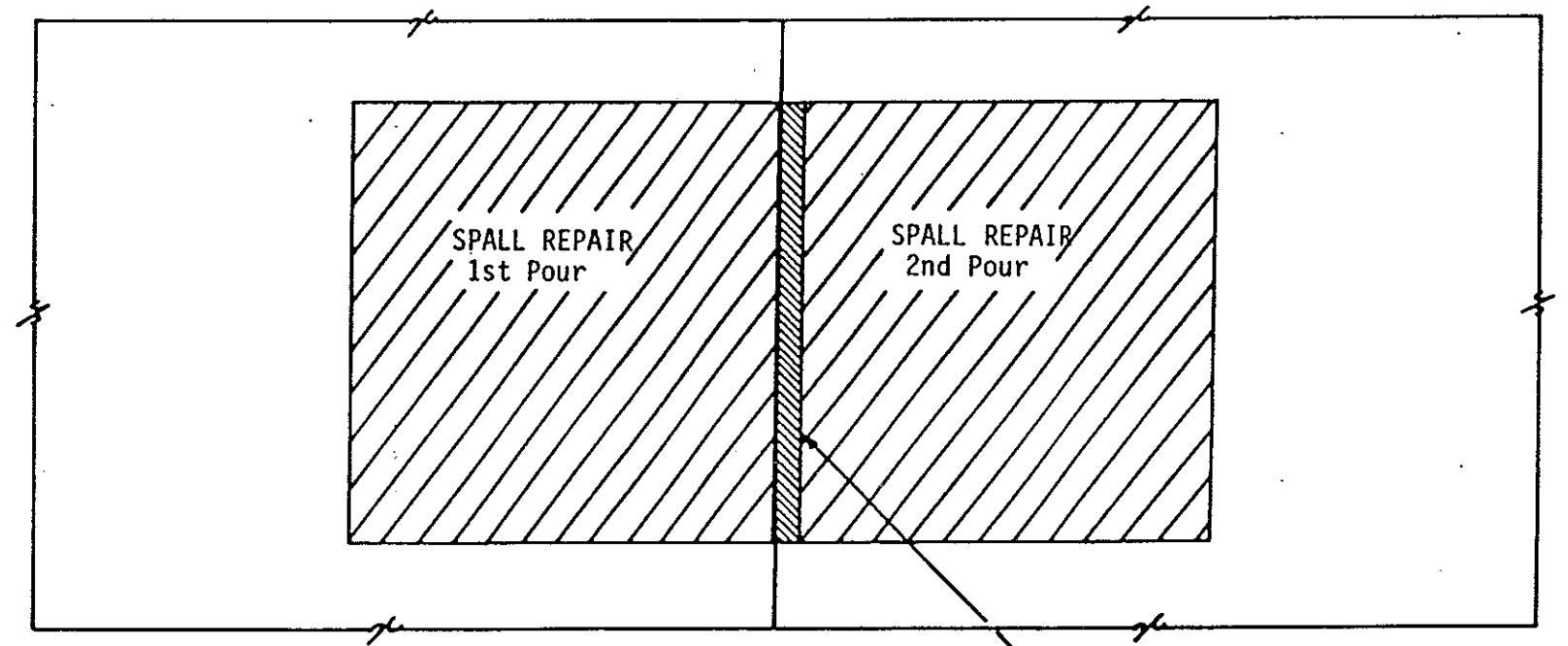

PLAN VIEW

Backing Board
(remove after 1st pour)

FHWA REGION	STATE	FED. AID PROJ. NO.	SHEET NO.
8	N.D.	F-1-094(006)015	

CONSTRUCTION JOINTS
Concrete Pavement & Joint Repair (Full Depth)

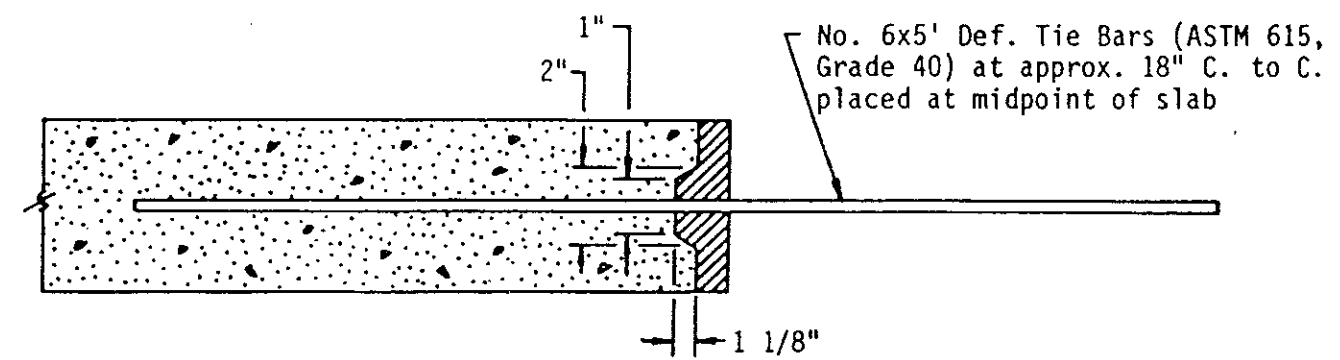

*TRANSVERSE CONSTRUCTION JOINT
(Keyed & Tied Joint)

NOTE: Construction joints to be formed to a depth of 1" and a width of 1/4" to 3/8" and sealed.

*To be used on large full depth repairs if more than one pour is made.

No separate payment shall be made for transverse construction joints. If the contractor elects to use the construction joints, the cost shall be included in the item "Joint Repair (Full Depth)" or "Concrete Pavement Repair (Full Depth)".

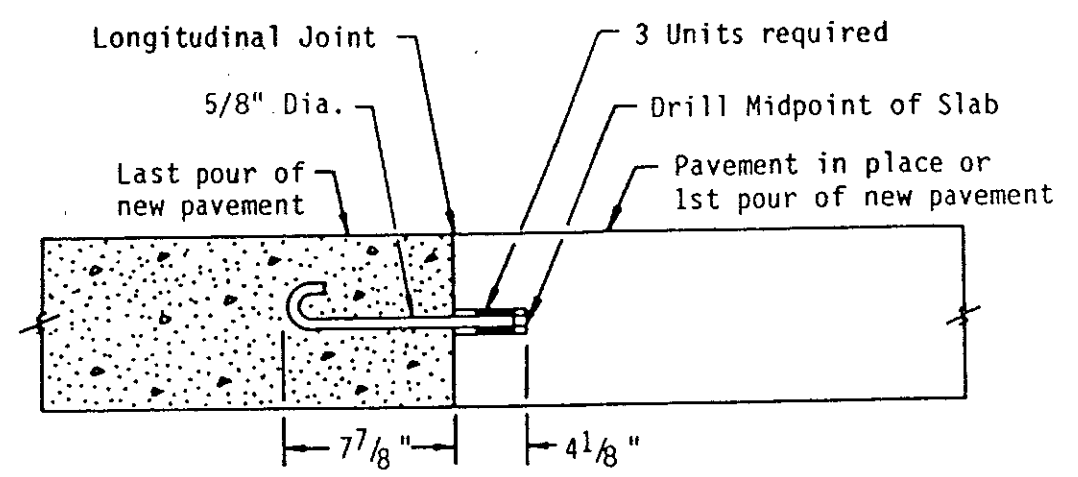

LONGITUDINAL JOINT

"J" Bolt Installation
(See Std. D-650-1)

NOTE: "J" Bolts shall be installed at approximately 4'-0" c. to c. on center line

2/9/87

PROJECT NO. F-1-094(006)915

SIGN NUMBER	SIGN SIZE	DESCRIPTION	AMOUNT REQUIRED	UNITS PER AMOUNT	UNITS SUB-TOTAL
R1-1-30	30" x 30"	STOP	4	17	68
R1-1-48	48" x 48"	STOP		34	0
R1-2-48	48" x 48"	YIELD & TO ONCOMING TRAFFIC		45	0
R2-1-48	48" x 60"	SPEED LIMIT		40	80
R2-5c-48	48" x 60"	SPEED ZONE AHEAD	2	40	80
R4-1-48	48" x 60"	DO NOT PASS		40	0
R4-7-48	48" x 60"	KEEP RIGHT SYMBOL	2	40	80
R4-8-48	48" x 60"	KEEP LEFT SYMBOL		40	0
R8-3-24	24" x 30"	NO PARKING	108	20	2160
R10-6-48	48" x 72"	STOP HERE ON RED		44	0
R11-2-48	48" x 30"	ROAD CLOSED		26	0
R11-3a-60	60" x 30"	ROAD CLOSED MILES AHEAD LOCAL TRAFFIC ONLY		30	0
R11-3b-60	60" x 30"	BRIDGE OUT MILES AHEAD LOCAL TRAFFIC ONLY		30	0
R11-2a-48	48" x 30"	STREET CLOSED	10	26	260
R11-3c-48	60" x 30"	STREET CLOSED MILES AHEAD LOCAL TRAFFIC ONLY		30	0
R11-4a-60	60" x 30"	STREET CLOSED TO THRU TRAFFIC	10	30	300
G20-1-60	60" x 36"	ROAD CONSTRUCTION NEXT MILES		34	0
G20-2-60	60" x 24"	END CONSTRUCTION	4	28	112
G20-2a-48	48" x 24"	END ROAD WORK		24	0
G20-4-36	36" x 18"	PILOT CAR FOLLOW ME		10	0
G20-50-72	72" x 36"	ROAD CONSTRUCTION NEXT MILES RT & LT ARROWS	20	38	760
G20-52-72	72" x 24"	ROAD CONSTRUCTION NEXT MILES RT or LT ARROW	5	30	150
G20-54-48	48" x 36"	OVERHEAD BRIDGE PAINTING		30	0
G20-8-48	48" x 36"	TEMPORARY SURFACE NEXT MILES		30	0
M4-10-48	18" x 48"	DETOUR ARROW RIGHT or LEFT		22	0
W1-1-48	48" x 48"	RIGHT or LEFT SHARP CURVE ARROW		34	0
W1-2-48	48" x 48"	RIGHT or LEFT CURVE ARROW		34	0
W1-3-48	48" x 48"	RIGHT or LEFT SHARP REVERSE CURVE ARROW	4	34	136
W1-4-48	48" x 48"	RIGHT or LEFT REVERSE CURVE ARROW		34	0
W1-6-48	48" x 24"	LARGE ARROW		26	0
W3-1a-48	48" x 48"	STOP AHEAD SYMBOL		34	0
W3-2a-48	48" x 48"	YIELD AHEAD SYMBOL		34	0
W3-3-48	48" x 48"	SIGNAL AHEAD SYMBOL		34	0
W4-2-48	48" x 48"	LANE TRANSITION SYMBOL	4	34	136
W5-1-48	48" x 48"	ROAD NARROWS		34	0
W6-3-48	48" x 48"	TWO WAY TRAFFIC SYMBOL		34	0
W8-1-48	48" x 48"	BUMP		34	0
W8-3a-48	48" x 48"	PAVEMENT ENDS SYMBOL		40	0
W8-3a-24	24" x 18"	PAVEMENT END PLAQUE		34	0
W8-9-48	48" x 48"	LOW SHOULDER		34	0
W8-51-48	48" x 48"	UNEVEN PAVEMENT		34	0
W8-53-48	48" x 48"	TRUCKS ENTERING HIGHWAY		34	0
W8-54-48	48" x 48"	TRUCKS ENTERING AHEAD or FT.	2	34	68
W8-55-48	48" x 48"	TRUCKS CROSSING AHEAD or FT.	2	34	68
W13-1-24	24" x 24"	MPH ADVISORY SPEED PLATE	1	10	10
W13-4-48	48" x 60"	RAMP ARROW		40	0
W20-1-48	48" x 48"	ROAD CONSTRUCTION - AHEAD, 1/2 MILE, or FT.	30	34	1020
W20-1a-48	48" x 48"	MEN WORKING SYMBOL		34	0
W20-2-48	48" x 48"	DETOUR		34	0
W20-3-48	48" x 48"	ROAD or STREET CLOSED AHEAD or FT.		34	0
W20-4-48	48" x 48"	ONE LANE ROAD AHEAD or FT.		34	0
W20-5-48	48" x 48"	RIGHT or LEFT LANE CLOSED AHEAD or FT.	6	34	204
W20-7a-48	48" x 48"	FLAGGING SYMBOL		34	0
W20-7k-24	24" x 18"	FEET		8	0
W20-8-48	48" x 48"	STREET CLOSED		34	0
W20-50-48	48" x 48"	BE PREPARED TO STOP		34	0
W20-51-48	48" x 48"	EQUIPMENT WORKING		34	0
W20-52-54	54" x 12"	NEXT MILES		10	0
W21-2-48	48" x 48"	FRESH OIL		34	0
W21-5-48	48" x 48"	SHOULDER WORK		34	0
W21-50-48	48" x 48"	BRIDGE PAINTING AHEAD or FT.		34	0
W21-51-48	48" x 48"	MATERIAL ON ROADWAY		34	0
W22-7-48	48" x 48"	SINGLE LANE AHEAD or FT.		34	0
W22-8-48	48" x 48"	FRESH OIL LOOSE ROCK		34	0
R1-1a-18	18" x 18"	STOP and SLOW PADDLE Back to Back		8	0
W22-14-18					
TOTAL UNITS					5692

TYPE III	8' LONG BARRICADES	EACH	36
TYPE II	2' MIN. BARRICADES	EACH	224
TYPE I	6' to 10' BARRICADES	EACH	
	18" x 36" MIN. DELINEATOR DRUMS	EACH	379
	28" MIN. TRAFFIC CONES	EACH	308
	8" to 12" x 24" VERTICAL PANELS	EACH	
	3" x 8" DELINEATOR	EACH	
	SEQUENCING ARROW PANEL TYPE C	EACH	2
	TEMPORARY STRIPE-SOLID LINE-TYPE R	LF	47920
		NR	

FHWA REGION	STATE	FED. AID PROJ. NO.	SHEET NO.
8	N.D.	F-1-094(006)915	

OBLITERATION OF PAVEMENT MARKING -----LF 9425

TRAFFIC CONTROL
Construction Area

Device List

MAIN AVENUE
MANDAN, ND

FHWA REGION	STATE	FED AID PROJ NO	SHEET NO.
8	N.D.	M-1-294 '003' P.C.C.	

CONSTRUCTION SEQUENCE

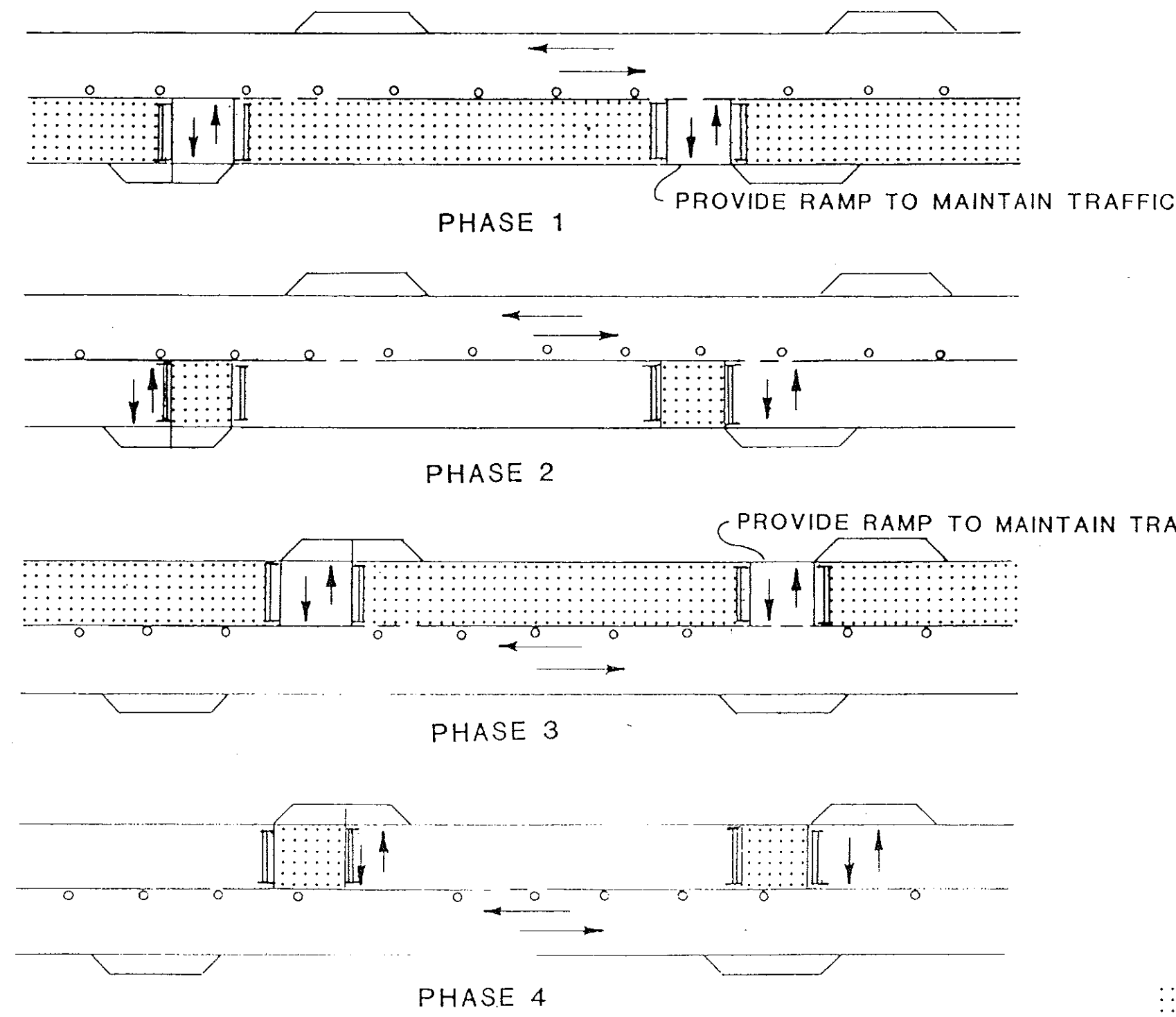

NOTES:

1. See Note 704-010 (Maintaining Access). Access shall be maintained on an all weather surface at all times.
2. Construction signing, arrow panels, cones, & delineator drums shall be located as shown on Traffic Control Layouts.
3. Sequence shown is a suggestion. Construction sequence & work area length to be determined by the contractor & approved by the Engineer.
4. High Early Strength PCC Pavement & weekend or 24 hour continuous operations may be necessary to provide access.
5. On-street parking shall be prohibited in the construction area and shall remain a no parking area after the completion of each segment.
6. Aggregate base course shall be paid for at unit price bid.

○ DELINEATOR DRUM

▒ WORK AREA

▮ TYPE II BARRICADE

INSTALL TEMPORARY STRIPE-SOLID LINE-TYPE R

4" YELLOW LINE 640 L.F.

4" WHITE LINE 320 L.F.

CONSTRUCTION SIGNING

MANDAN MAIN STREET

WEST END

PYWA REGION	STATE	FED. AID PROJ. NO.	SHEET NO.
8	N.D.		

F-1-094(006)915

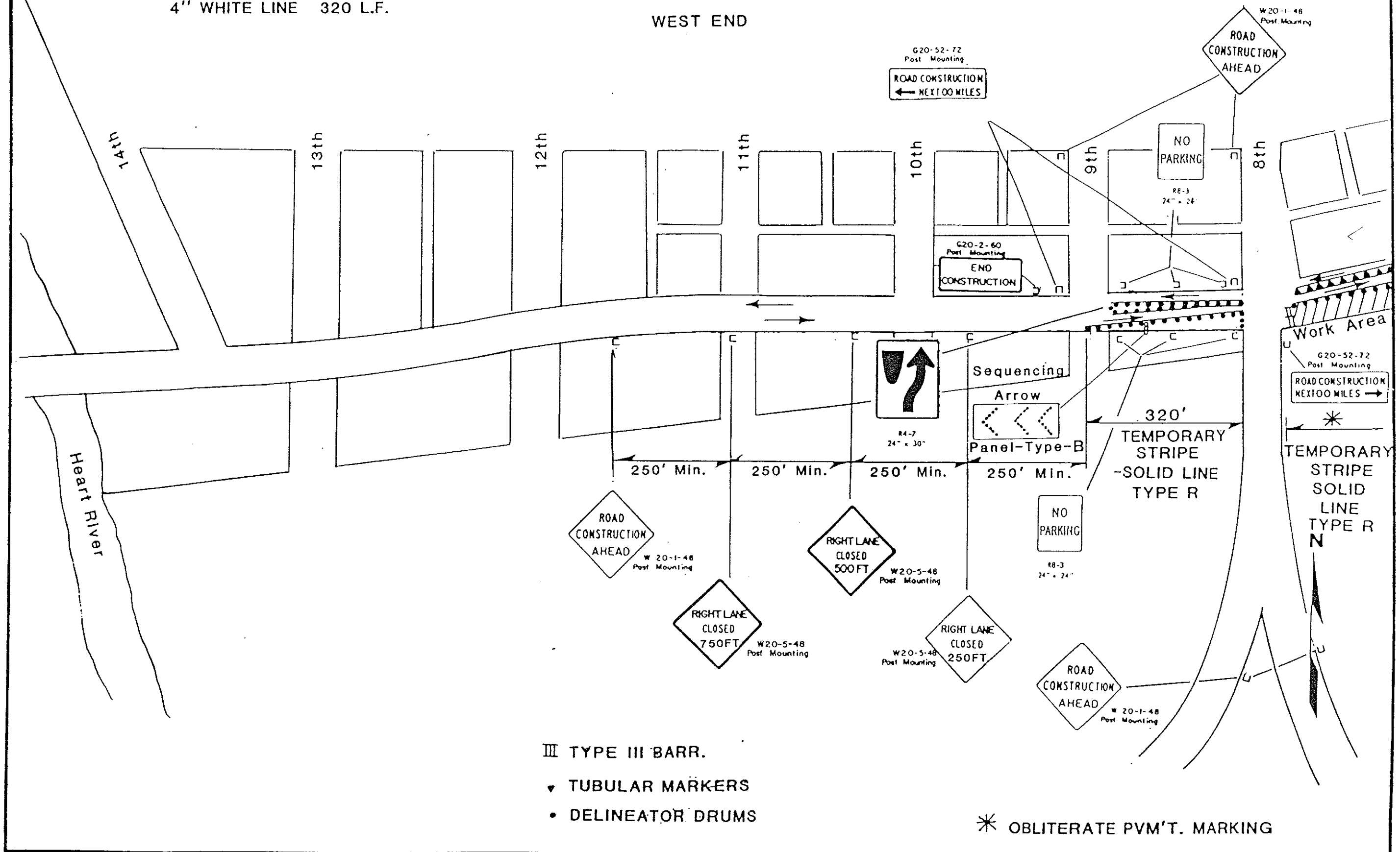

III TYPE III BARR.

▼ TUBULAR MARKERS

• DELINEATOR DRUMS

* OBLITERATE PVM'T. MARKING

PLANS REGION	STATE	FED. AID PROJ. NO.	SHEET NO.
8	N.D.		

F-1-094(008)915

INSTALL TEMPORARY STRIPE LINE-TYPE R
4" YELLOW LINE 600 L.F.

CONSTRUCTION SIGNING
MANDAN MAIN STREET
WEST END

OBLITERATION OF PAVEMENT MARKING 75 L.F.

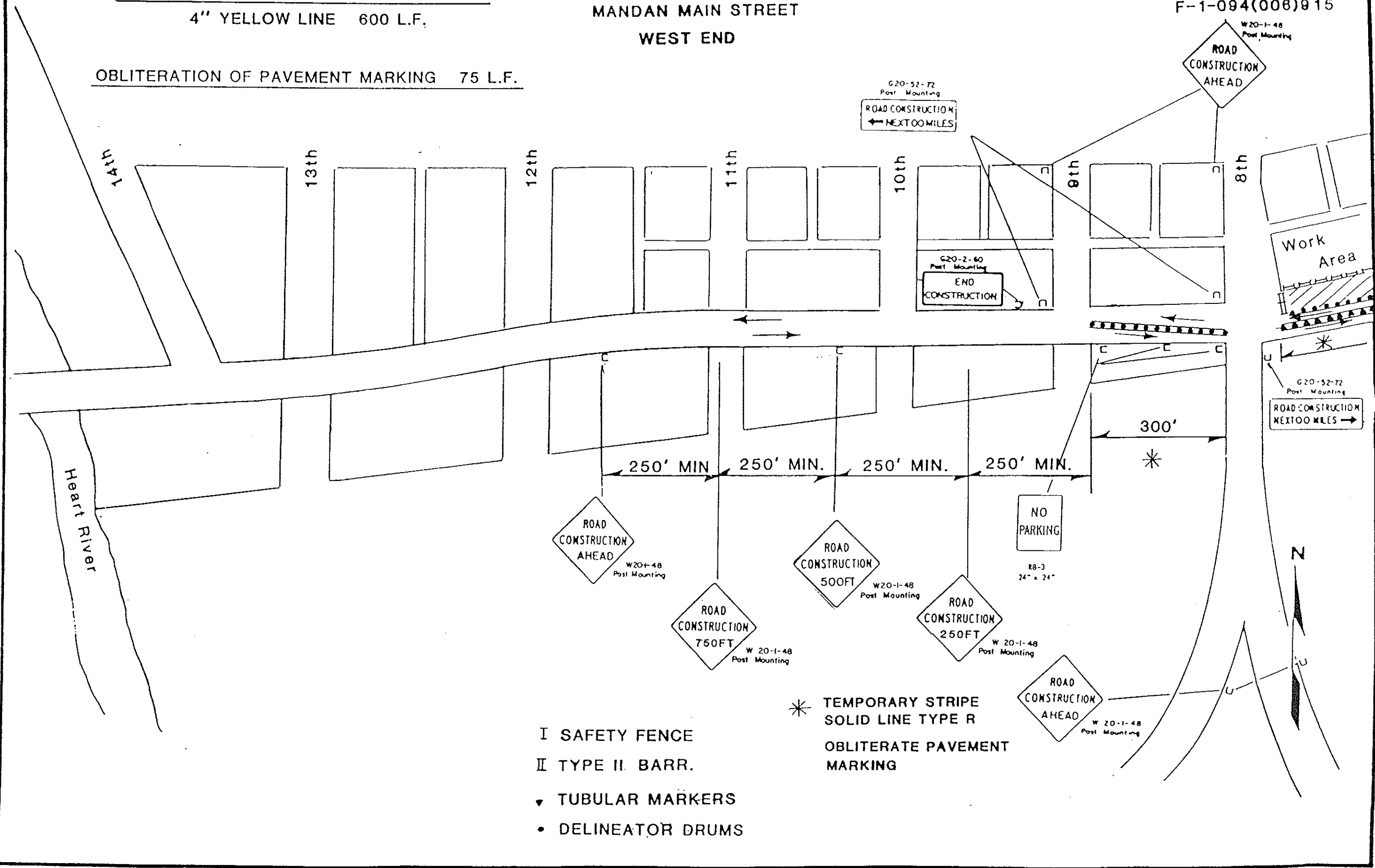

- I SAFETY FENCE
- II TYPE II BARR.
- ▼ TUBULAR MARKERS
- DELINEATOR DRUMS

* TEMPORARY STRIPE
SOLID LINE TYPE R
OBLITERATE PAVEMENT
MARKING

FHWA REGION	STATE	FED. AID PROJ. NO.	SHEET NO.
8	N.D.	F-1-094(006)915	

CONSTRUCTION SIGNING
MANDAN MAIN STREET
NORTH LANES CLOSED

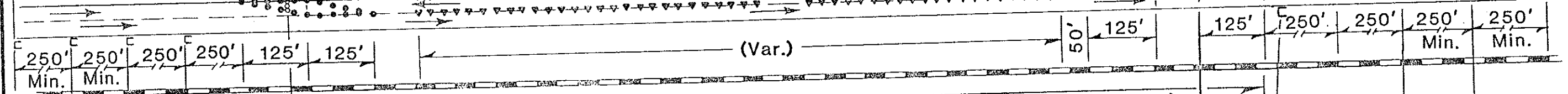
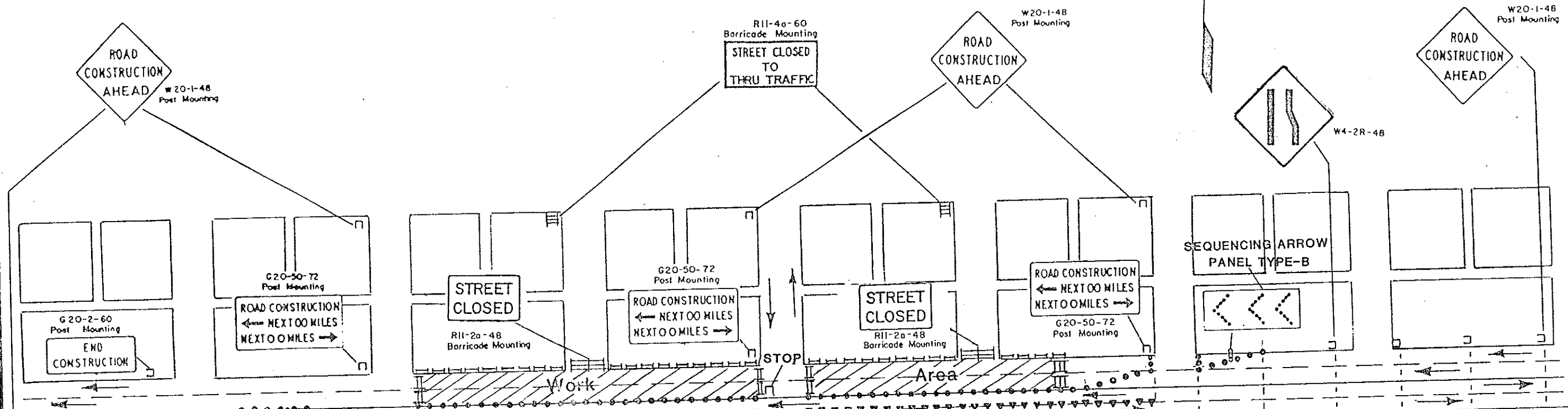

PROVIDE NO PARKING SIGNS R8-3-24 at AT SP. OF 150' MAX.
BOTH SIDES OF ROADWAY

INSTALL TEMPORARY STRIPE-SOLID LINE-TYPE R
4" WHITE LINE 7700 L.F.
4" YELLOW LINE 15400 L.F.

- SAFETY FENCE
- ≡ TYPE III BARR.
- ▼ TUBULAR MARKERS
- DELINEATOR DRUMS
- ≡ TYPE II BARR.

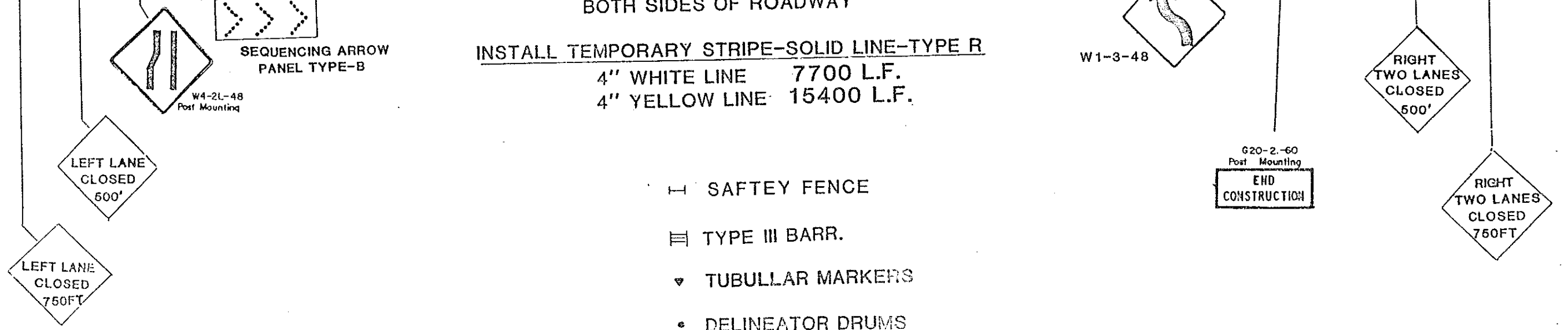

FHWA REGION	STATE	FED. AID PROJ. NO.	SHEET NO.
8	N.D.		

F-1-094(006)915

CONSTRUCTION SIGNING
MANDAN MAIN STREET
SOUTH LANES CLOSED

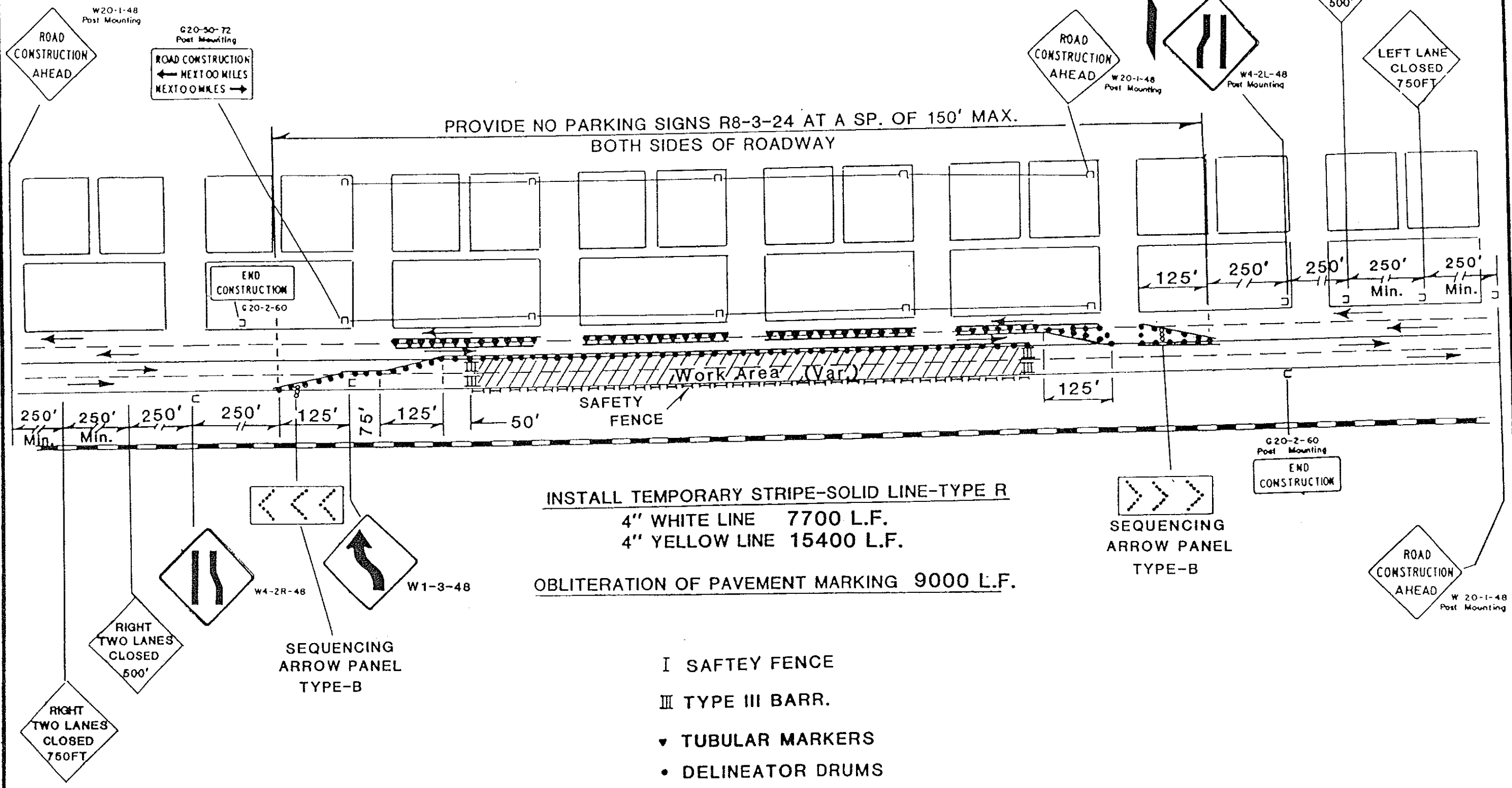

PROVIDE NO PARKING SIGNS R8-3-24 AT A SP. OF 150' MAX.
BOTH SIDES OF ROADWAY

INSTALL TEMPORARY STRIPE-SOLID LINE-TYPE R
4" WHITE LINE 7700 L.F.
4" YELLOW LINE 15400 L.F.
OBLITERATION OF PAVEMENT MARKING 9000 L.F.

- I SAFTEY FENCE
- III TYPE III BARR.
- ▼ TUBULAR MARKERS
- DELINEATOR DRUMS

CONSTRUCTION SIGNING
MANDAN MAIN STREET
(East End C.R.R.)

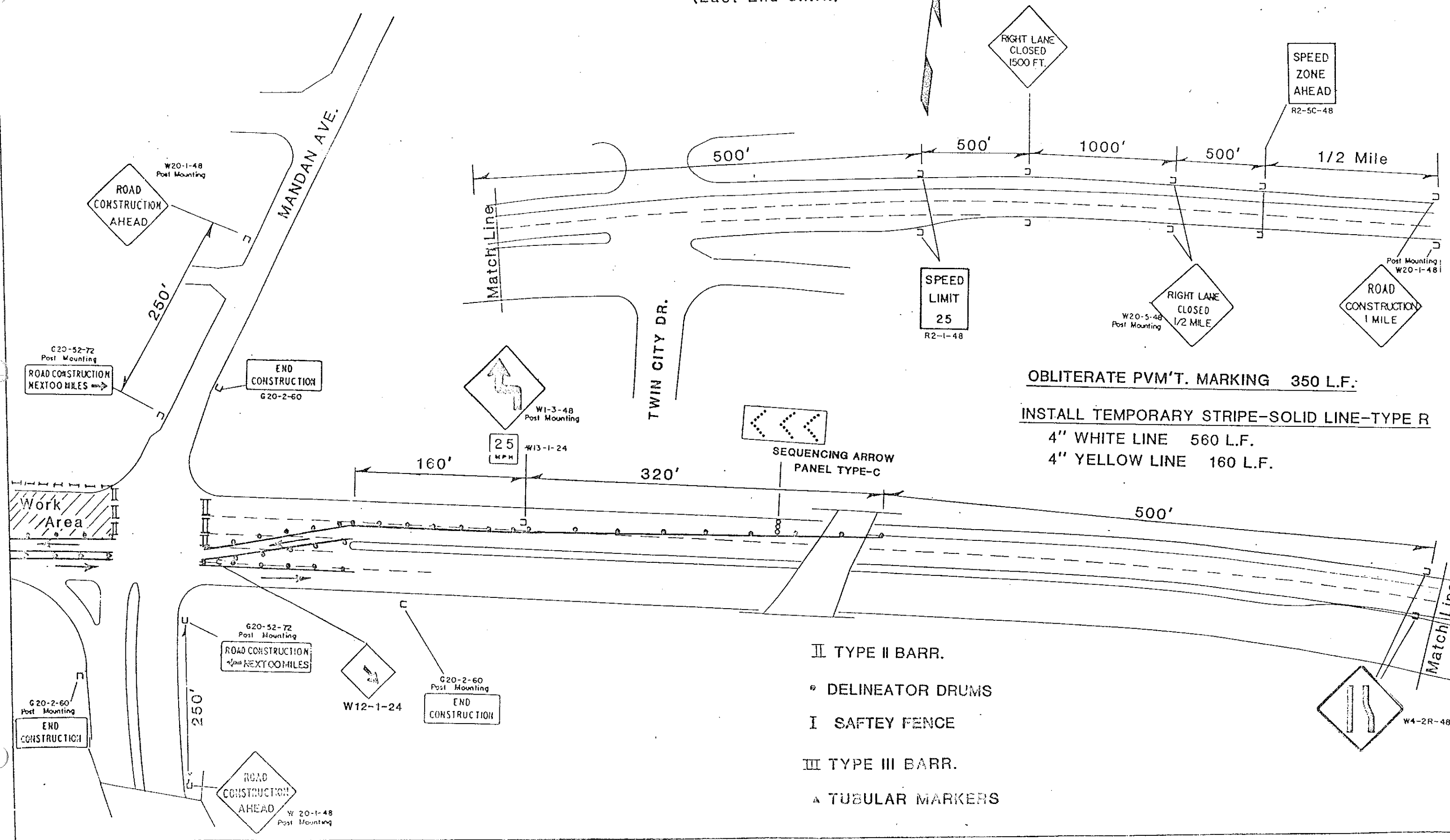

OBLITERATE PVM'T. MARKING 350 L.F.
 INSTALL TEMPORARY STRIPE-SOLID LINE-TYPE R
 4" WHITE LINE 560 L.F.
 4" YELLOW LINE 160 L.F.

- II TYPE II BARR.
- DELINEATOR DRUMS
- I SAFETY FENCE
- III TYPE III BARR.
- ▲ TUBULAR MARKERS

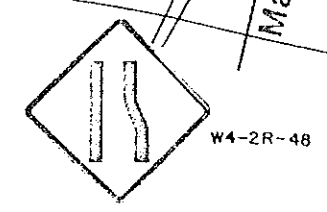

Work Area

Match Line

Match Line

TWIN CITY DR.

MANDAN AVE.

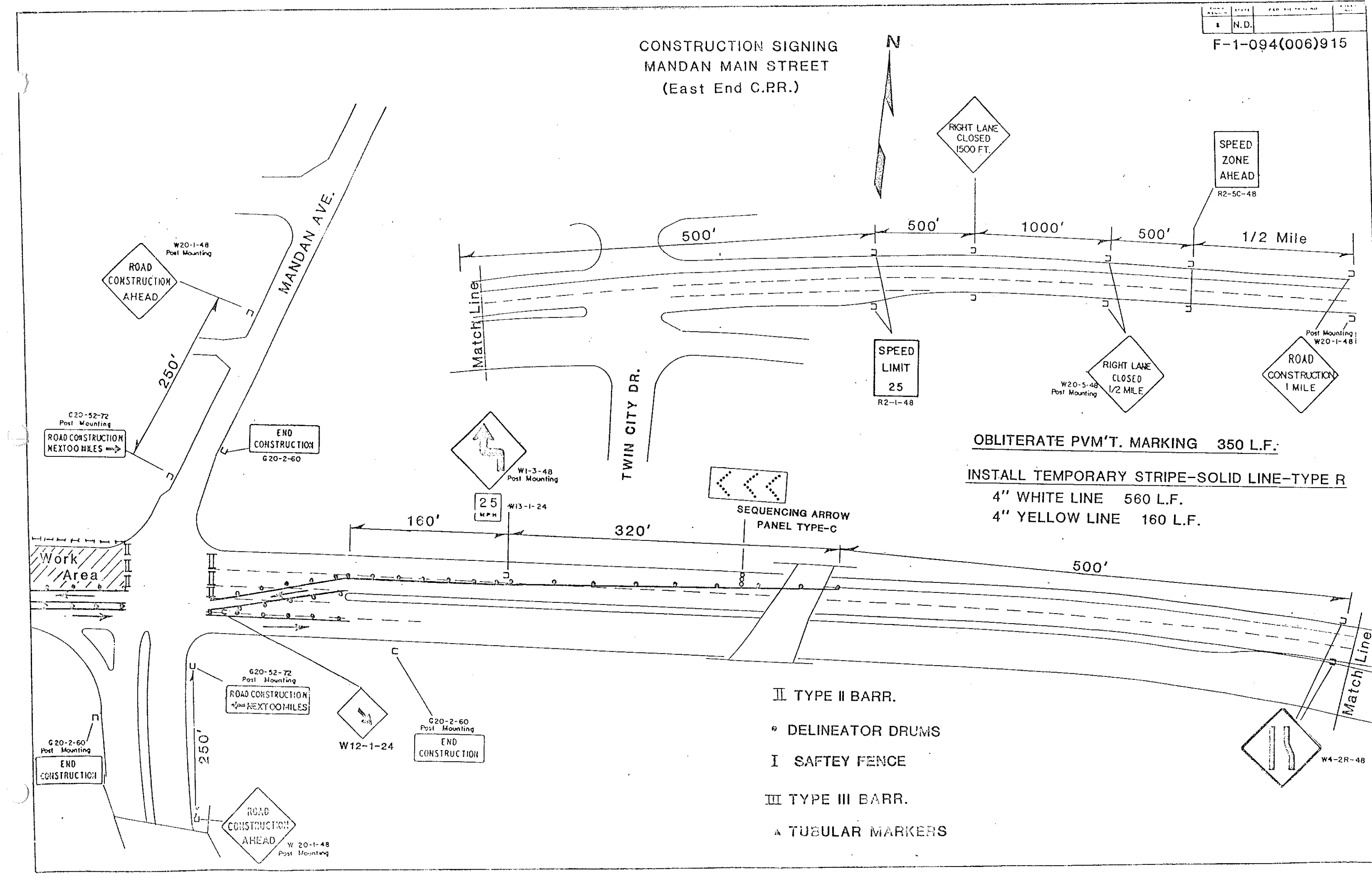

CONSTRUCTION SIGNING
MANDAN MAIN STREET
(East End C.P.R.)

INSTALL TEMPORARY STRIPE-SOLID LINE-TYPE R
4" YELLOW LINE 400 L.F.

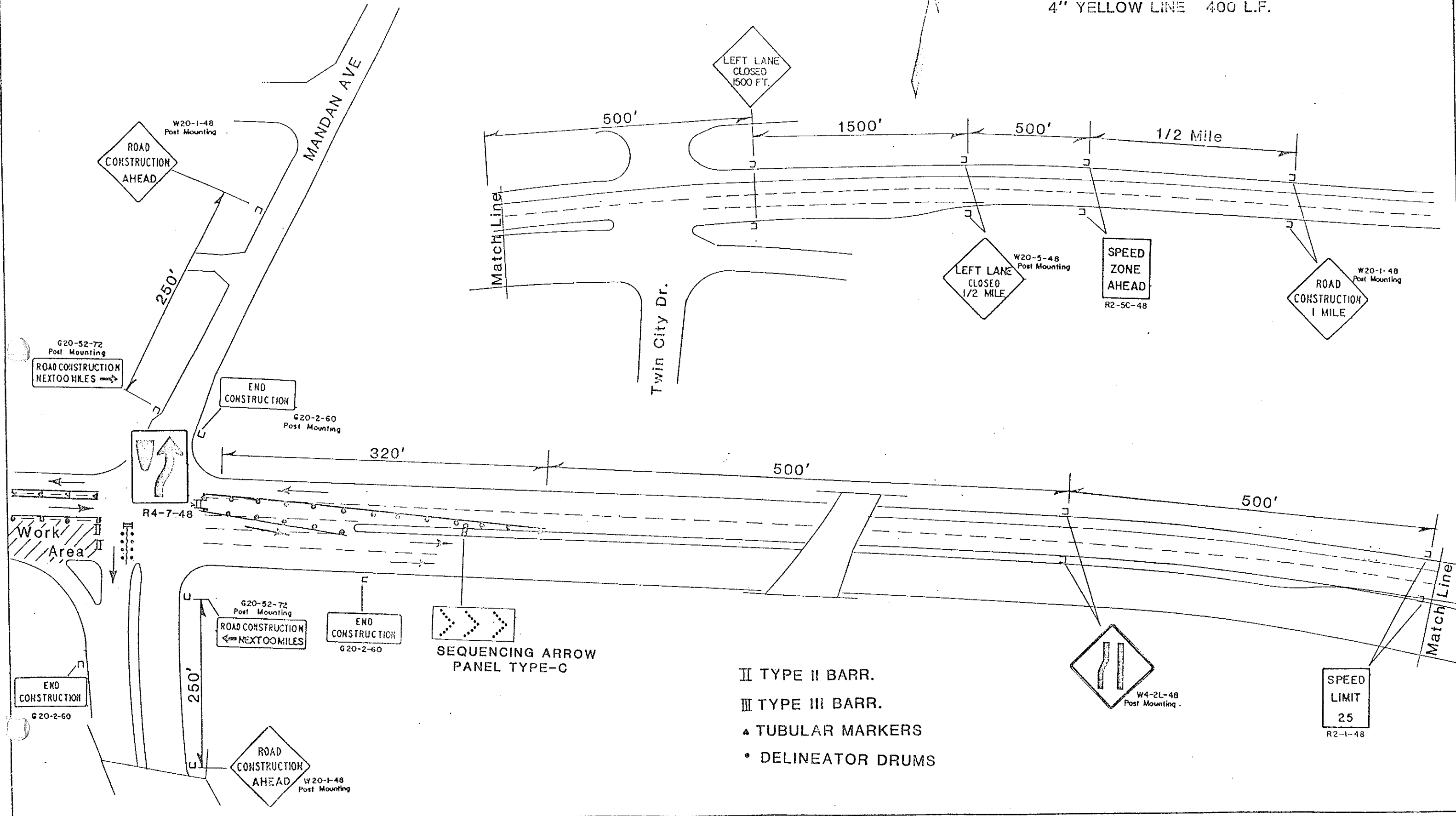

- II TYPE II BARR.
- III TYPE III BARR.
- ▲ TUBULAR MARKERS
- DELINEATOR DRUMS